

левая рука

Найди и назови одинаковые картинки слева и справа. Обведи их двумя руками одновременно

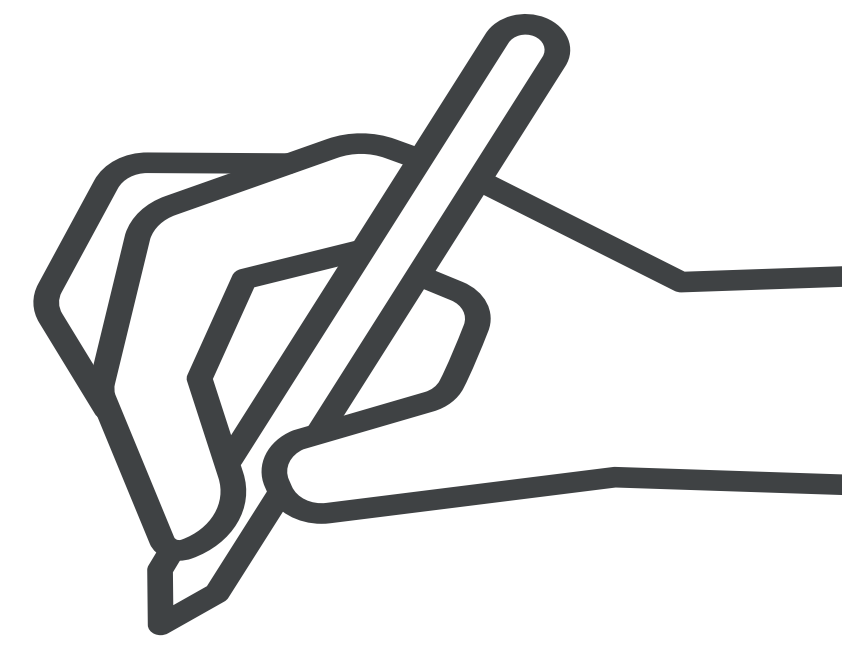

правая рука

# Альбом для автоматизации звуков

[С], [С'], [З], [З'], [Ц], [Ч], [Щ], [Ш], [Ж], [Л], [Л'], [Р], [Р']

развитие межполушарных связей

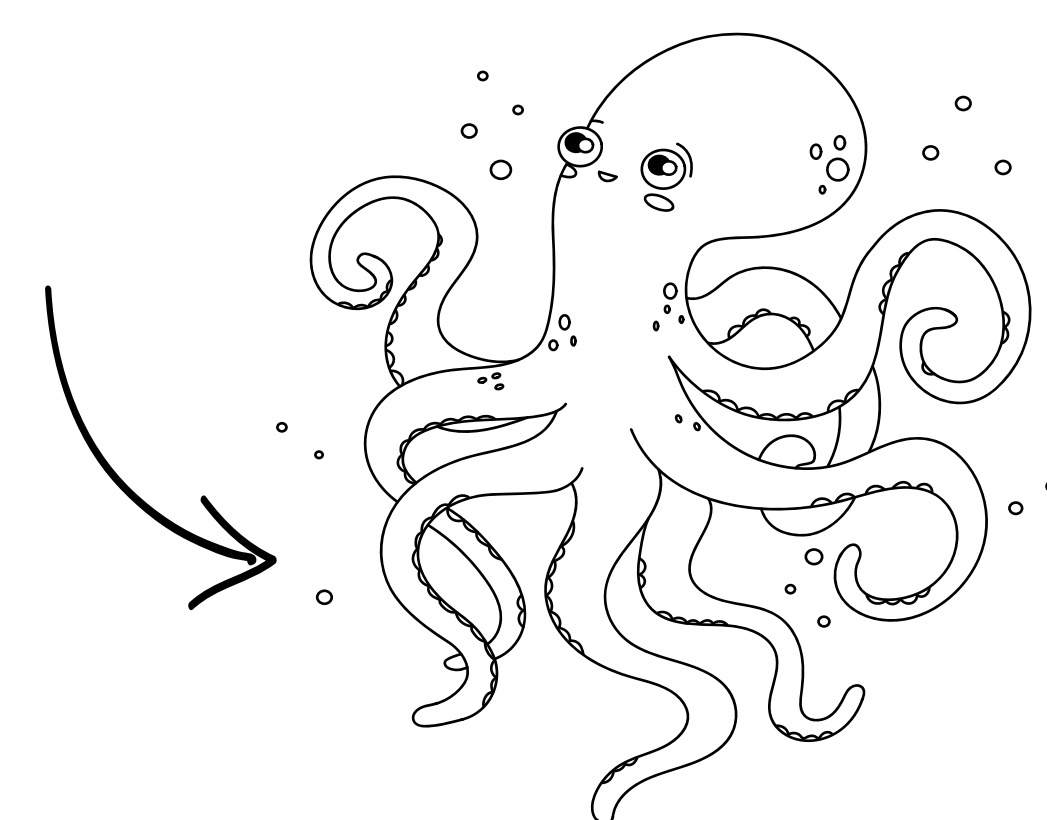
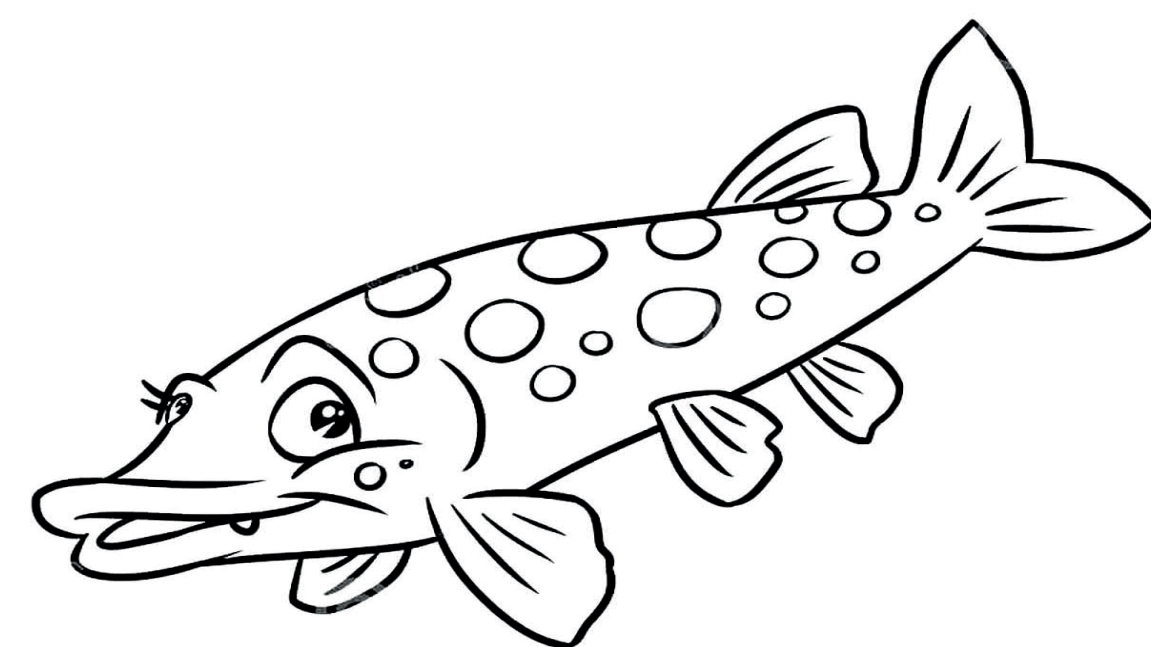
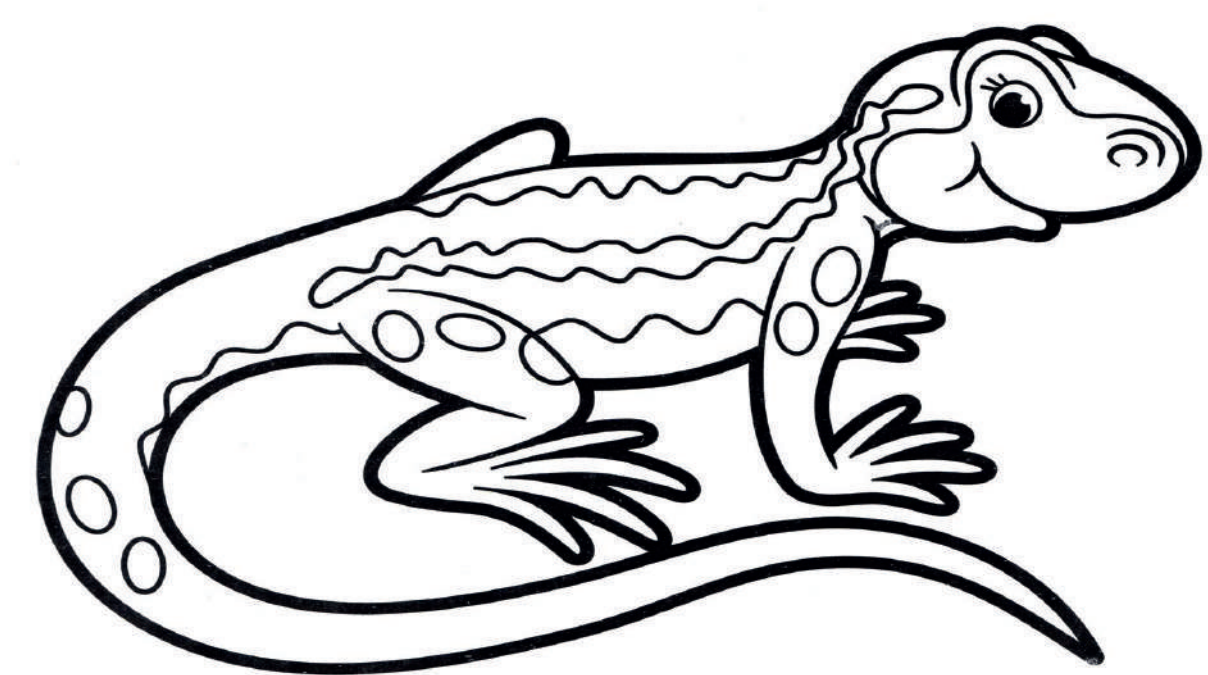
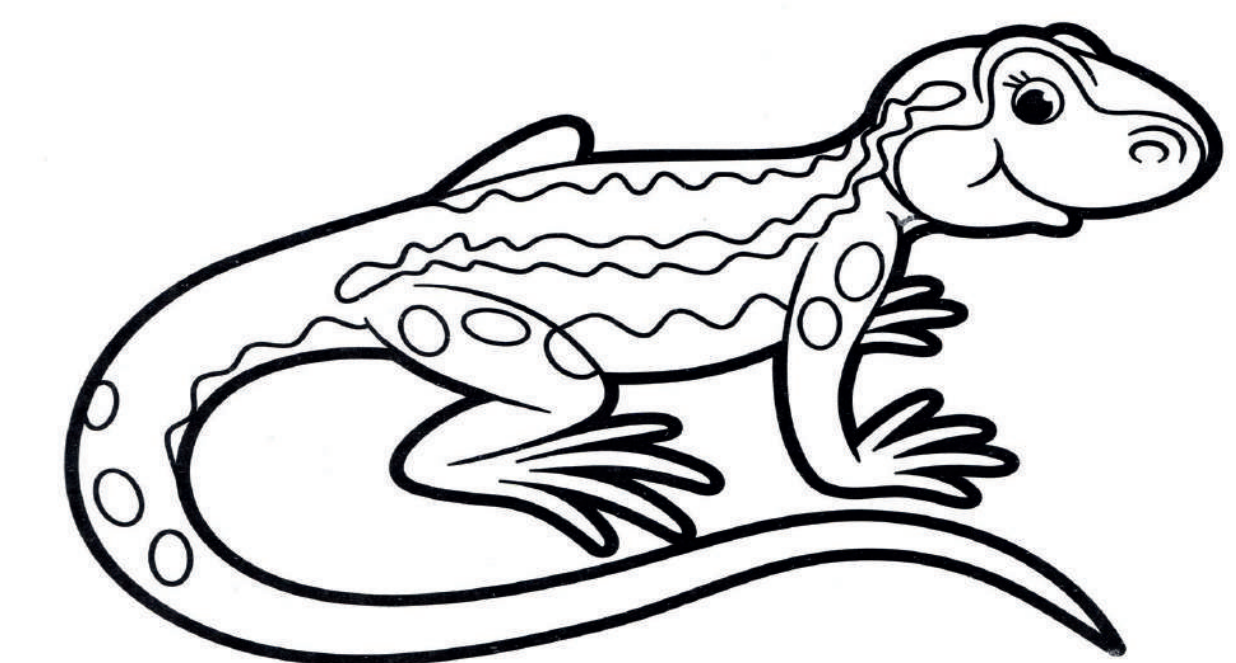
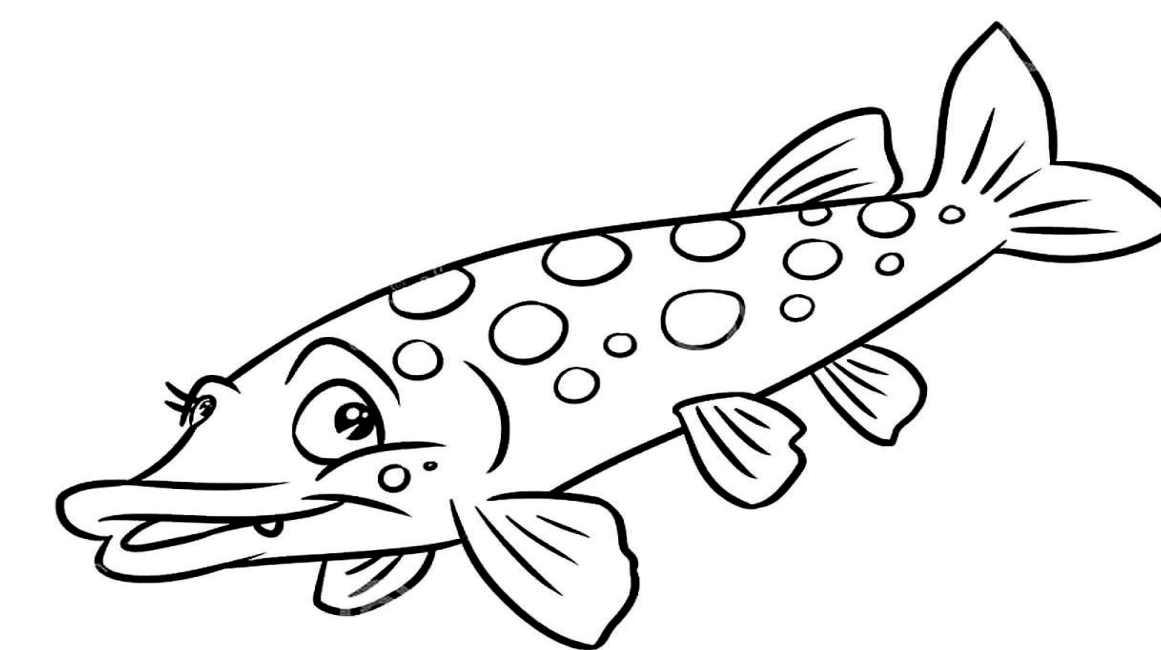
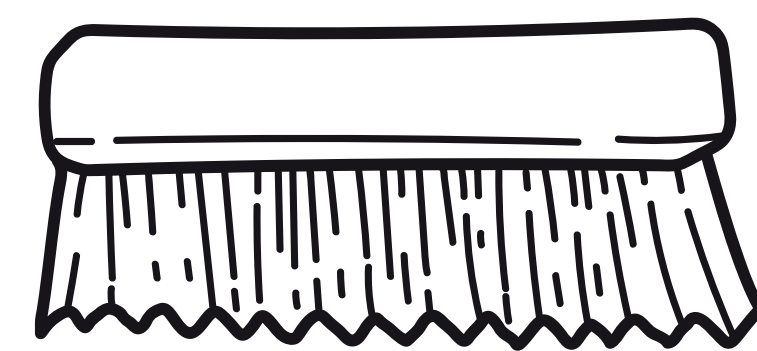
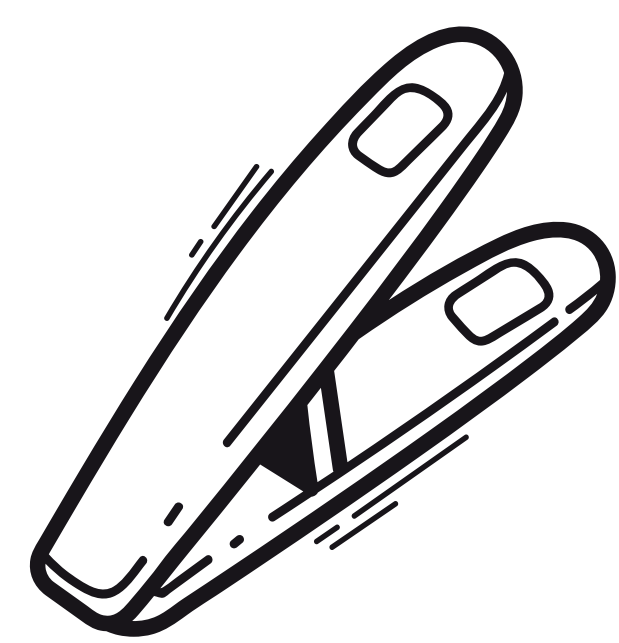
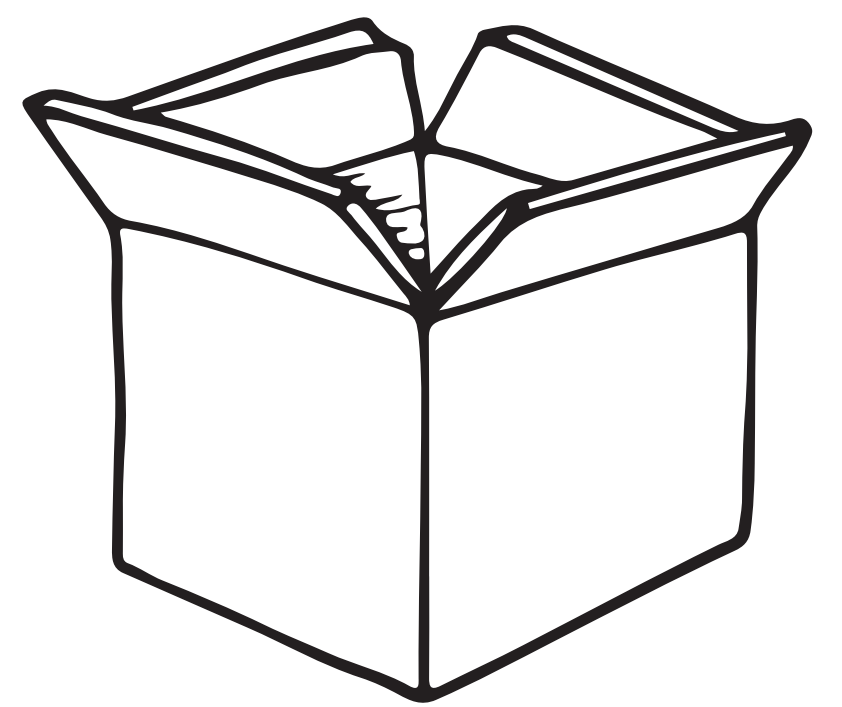
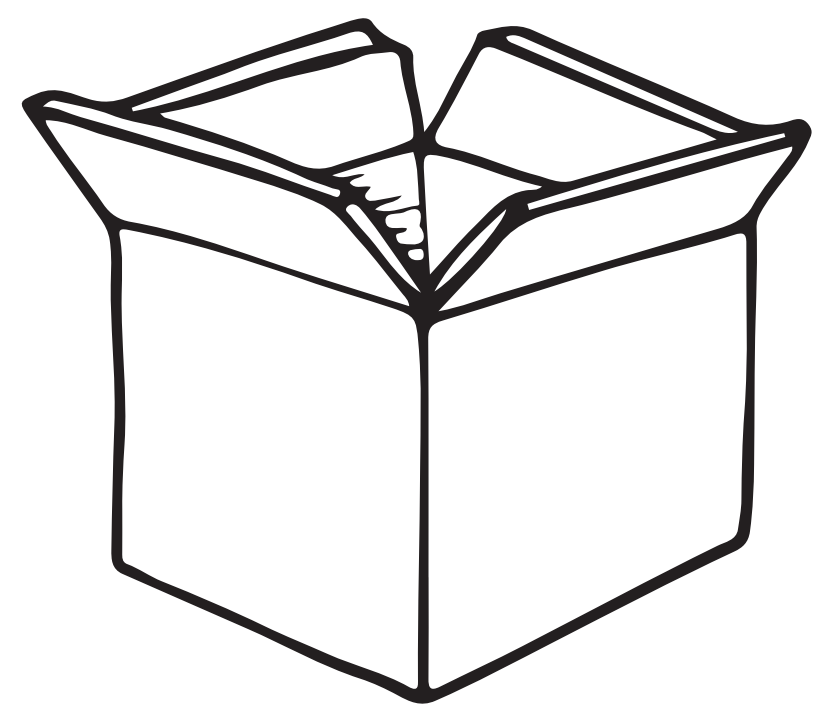

[deti-i-mama.ru](http://deti-i-mama.ru)

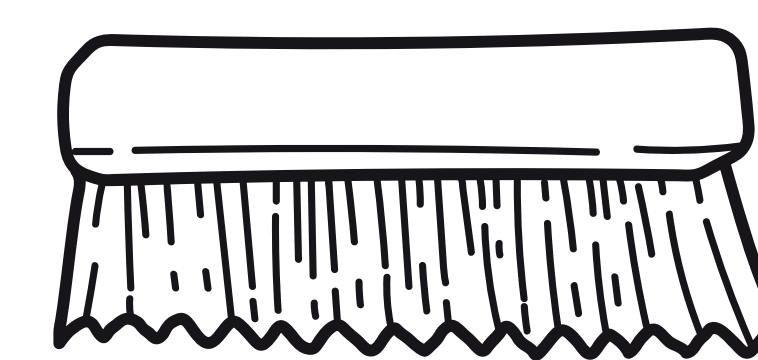

[vini.by](http://vini.by)

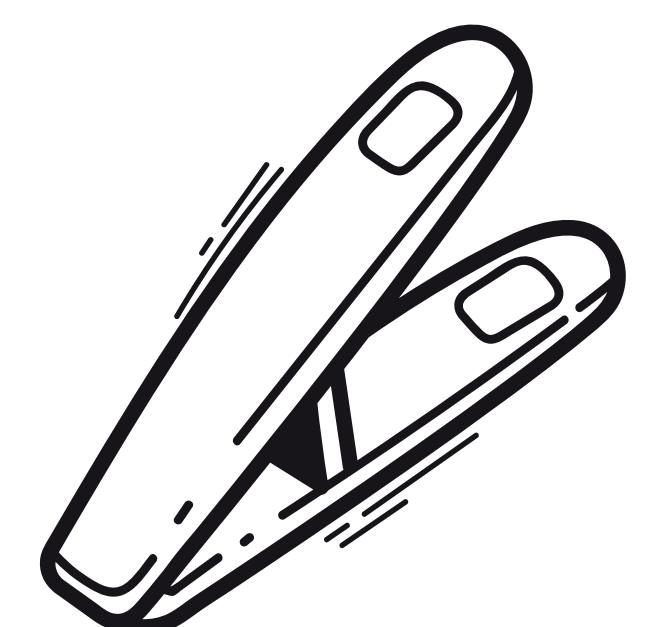
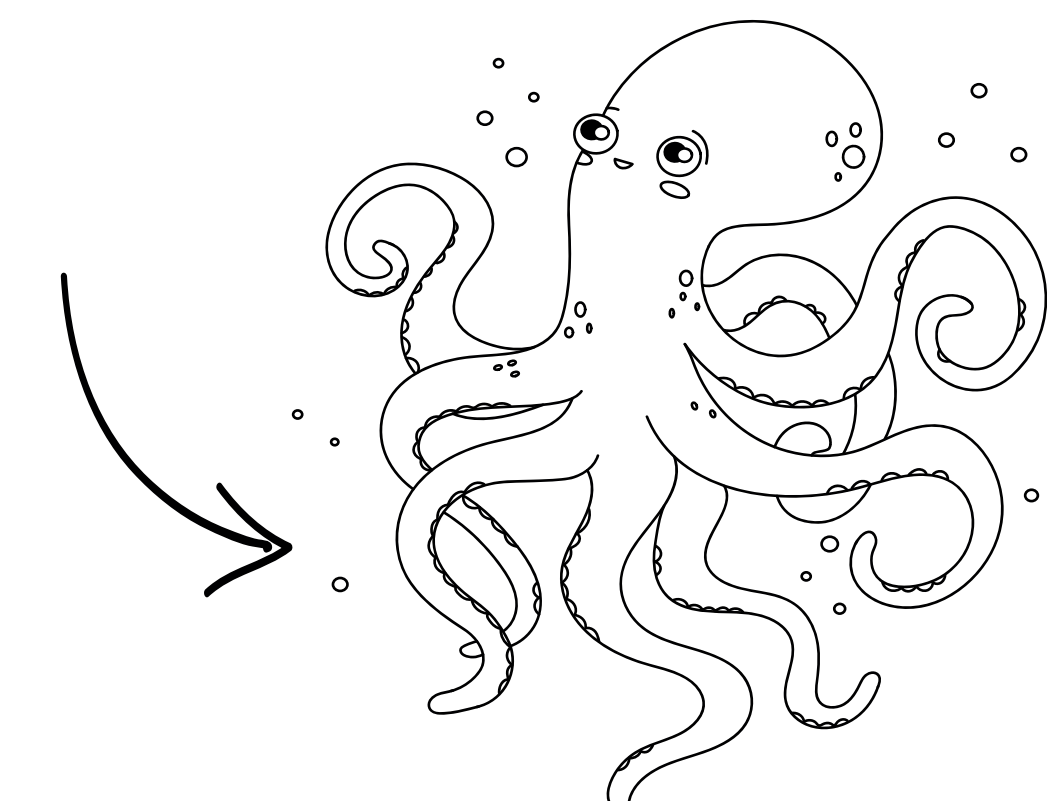



С

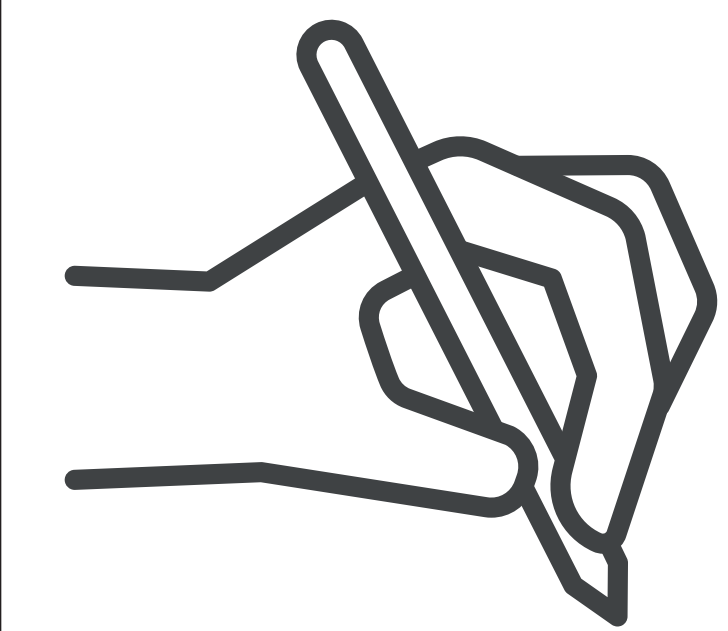

левая рука

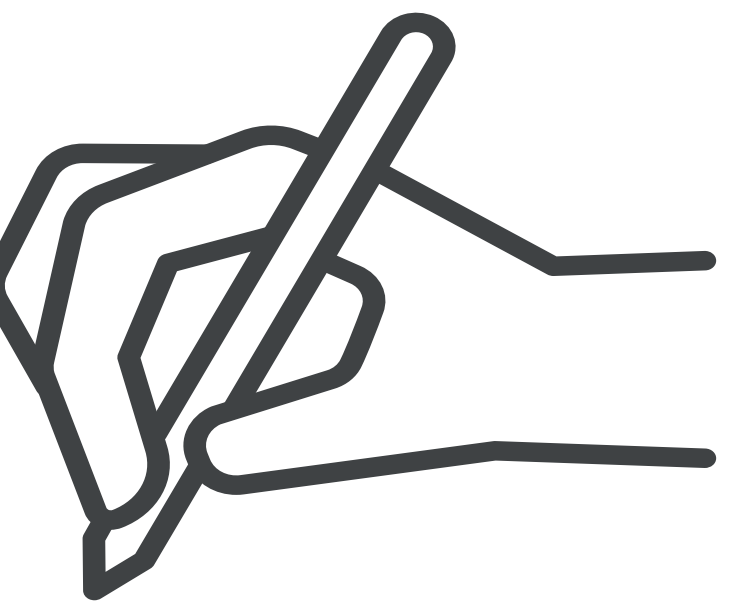

правая рука

Найди и назови одинаковые картинки слева и справа. Обведи их двумя руками одновременно



deti-i-mama.ru

vini.by



С'

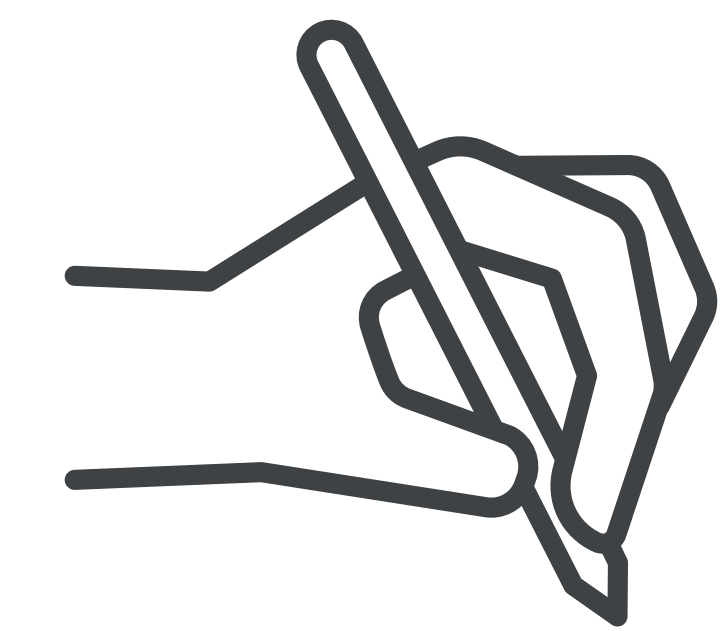

левая рука

Найди и назови одинаковые картинки слева и справа. Обведи их двумя руками одновременно

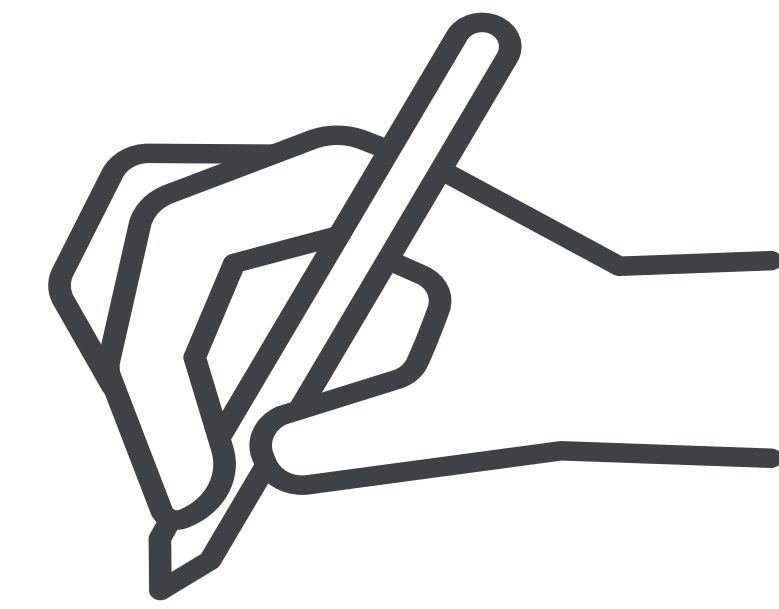

правая рука

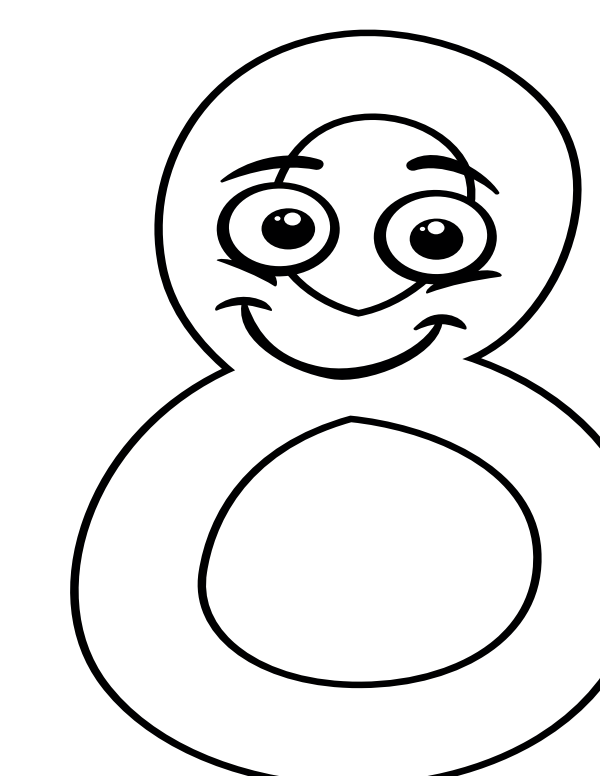
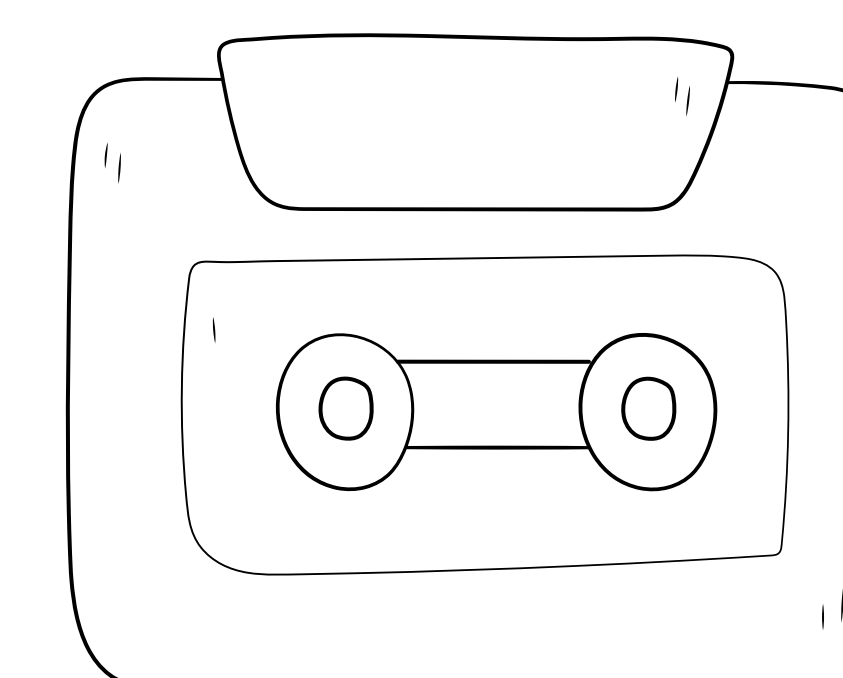
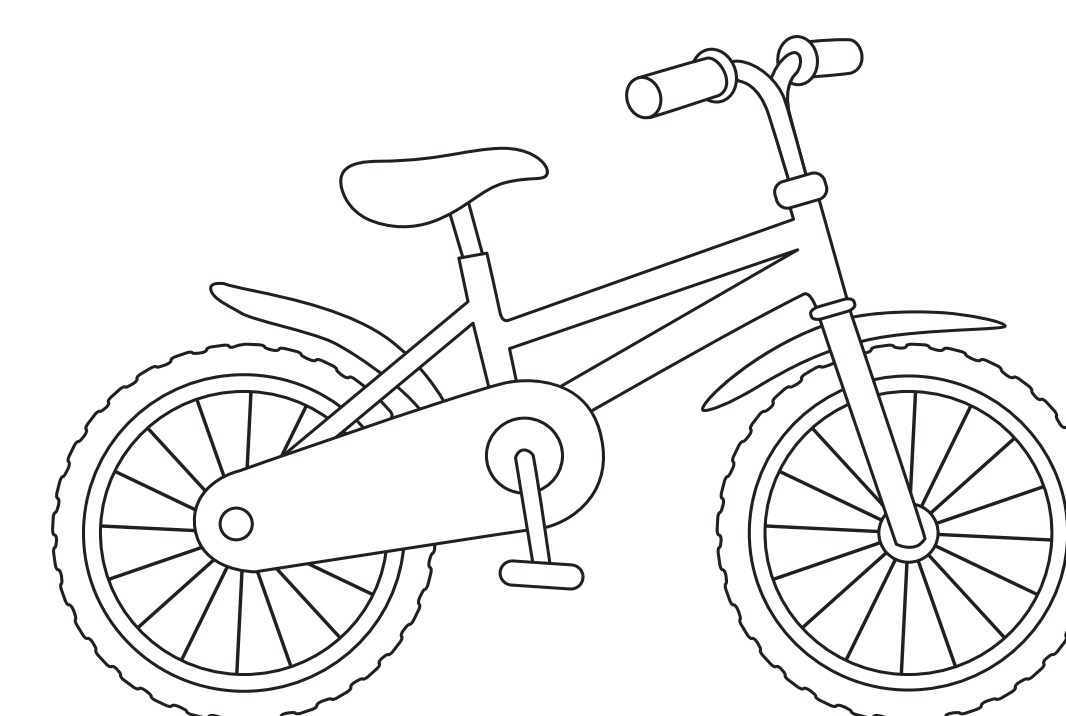
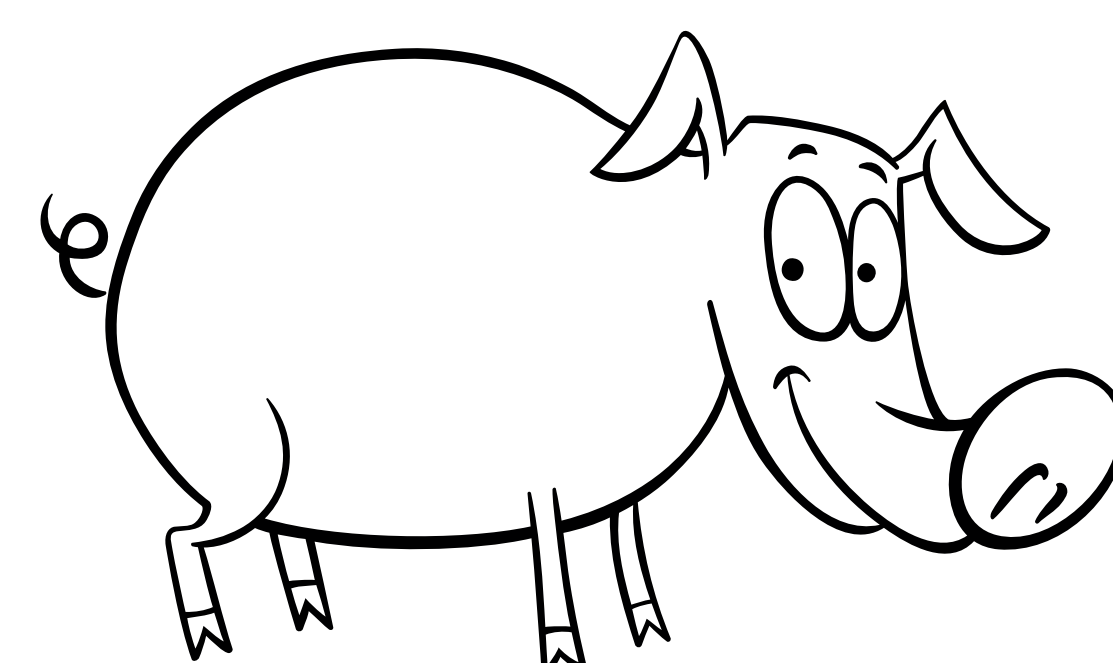
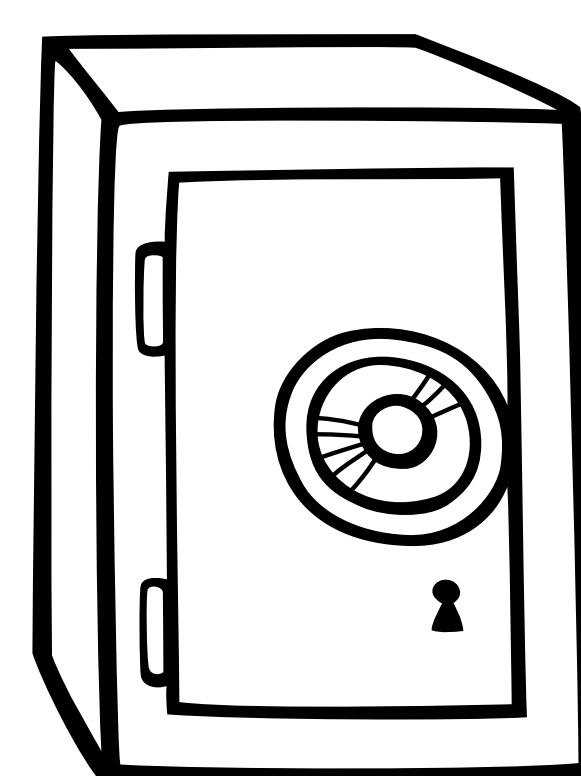
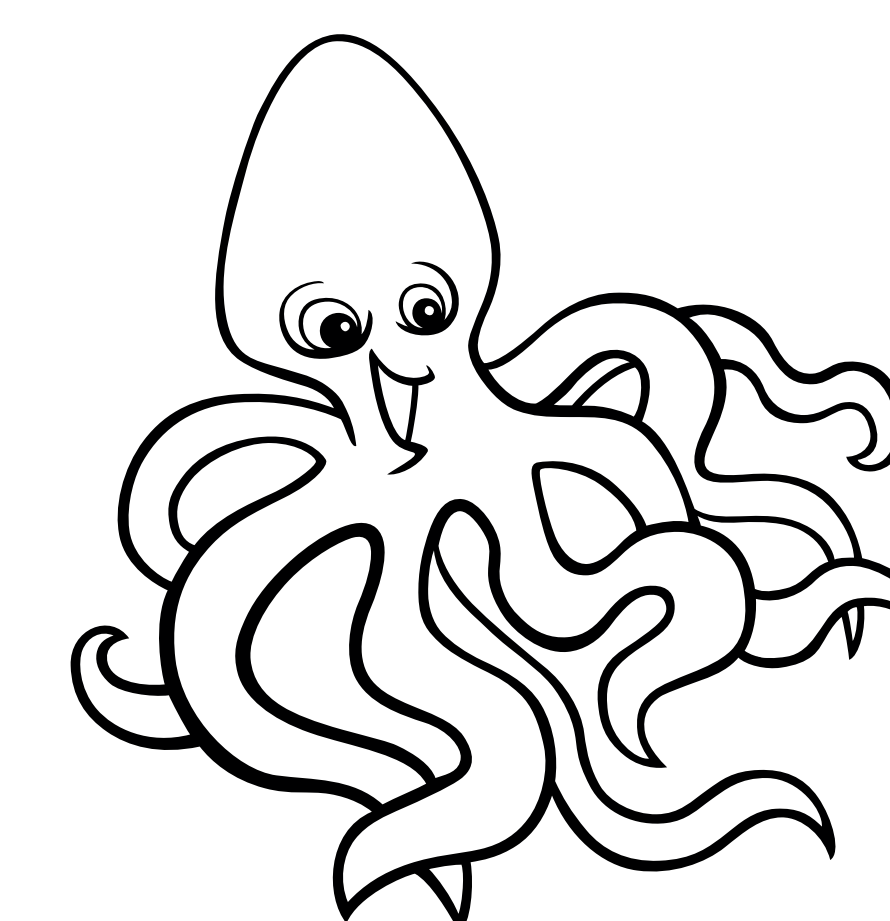
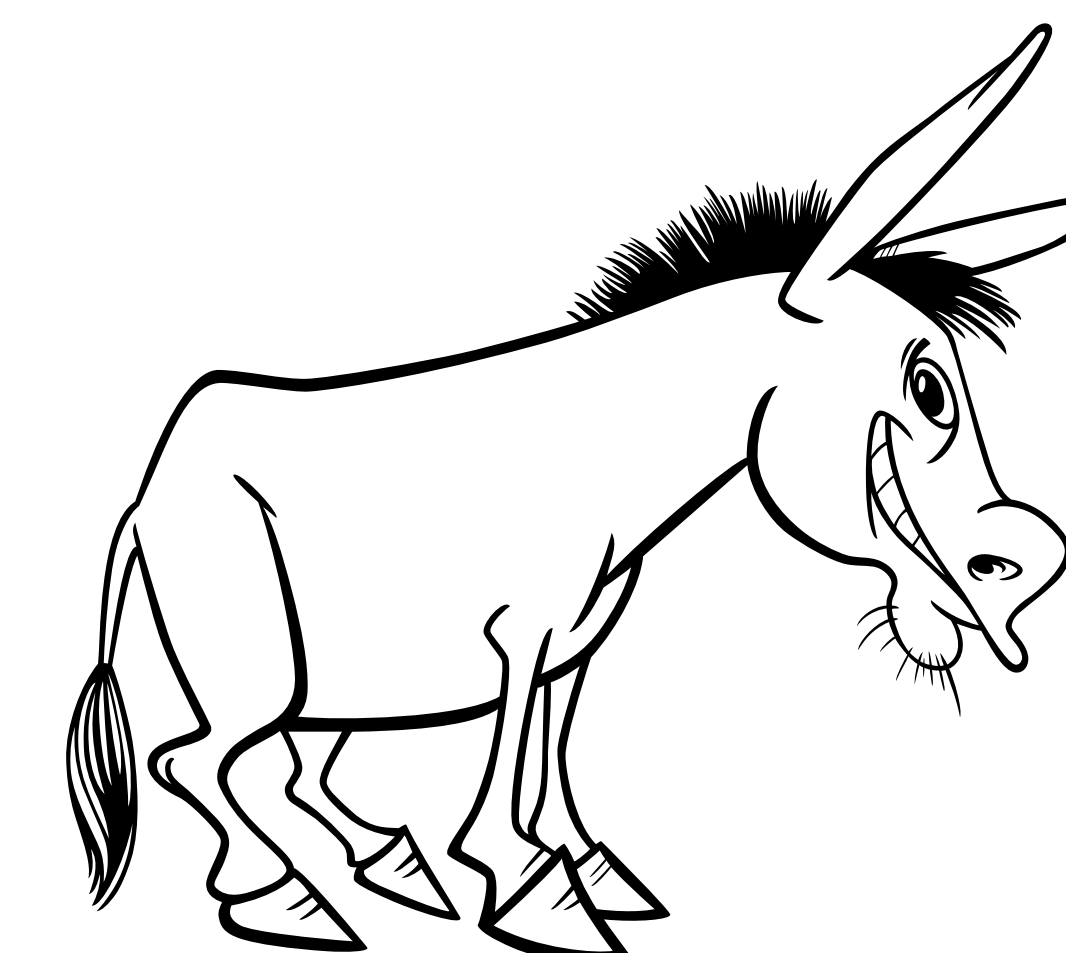
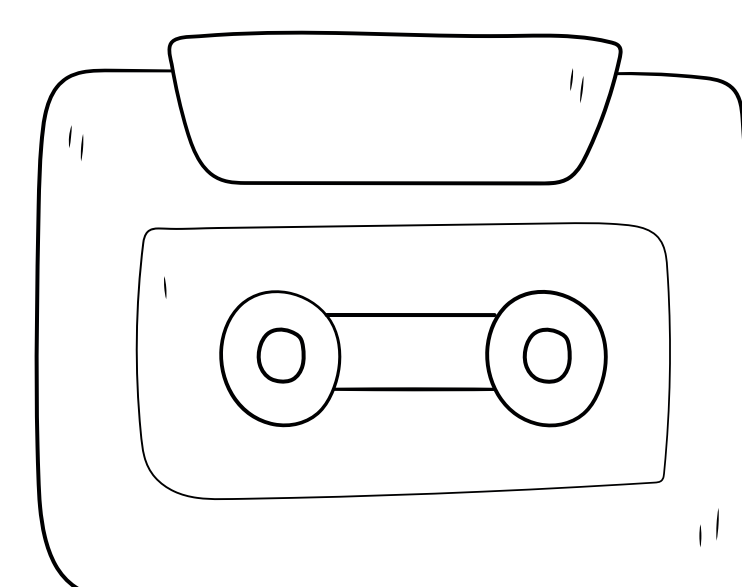
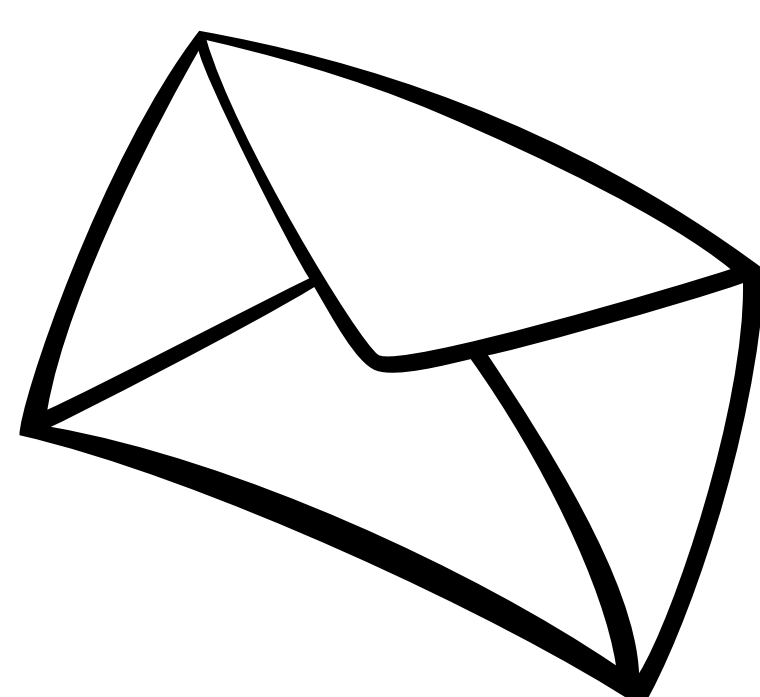
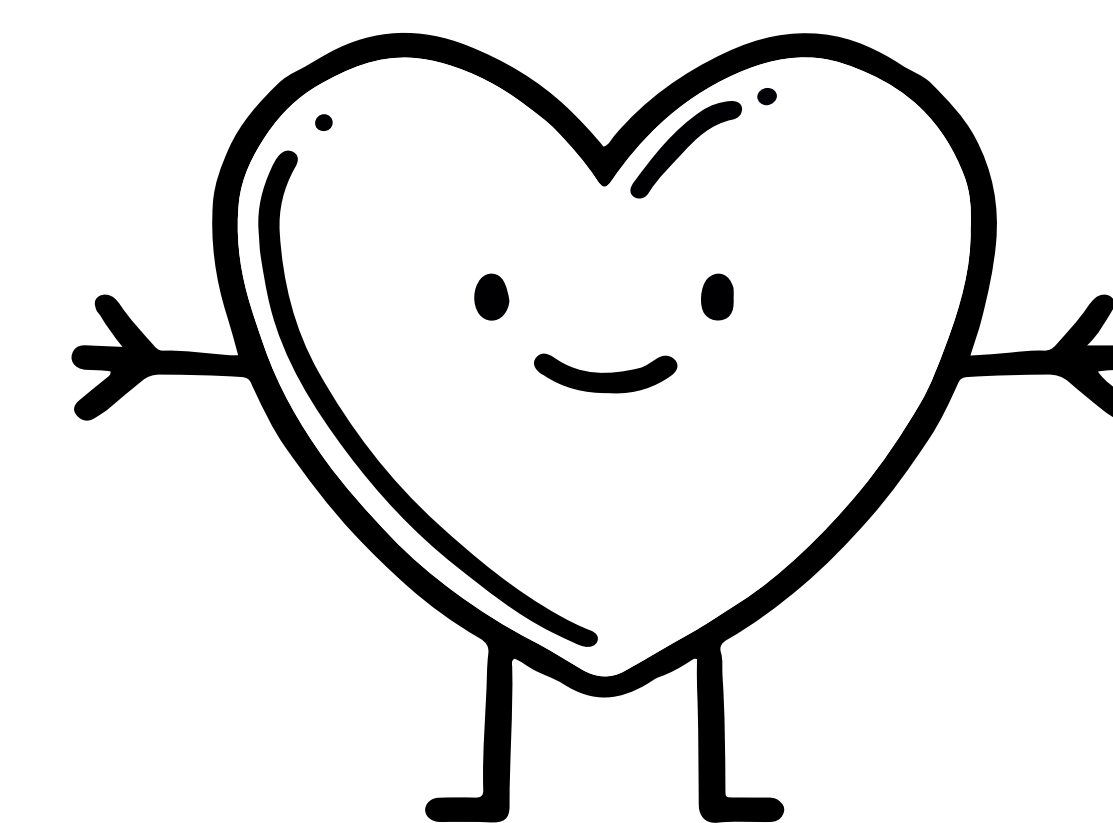
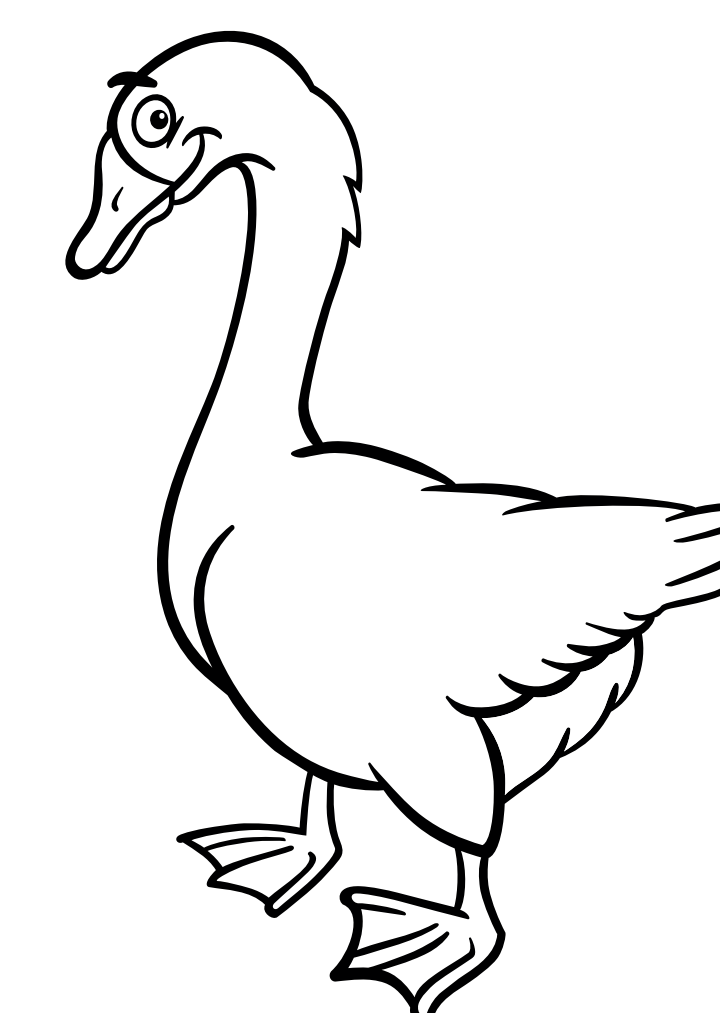
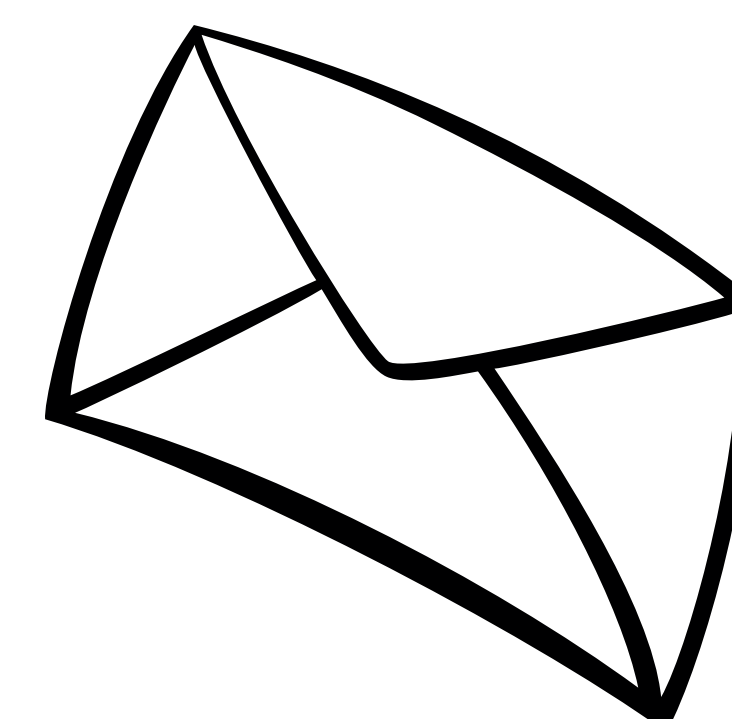
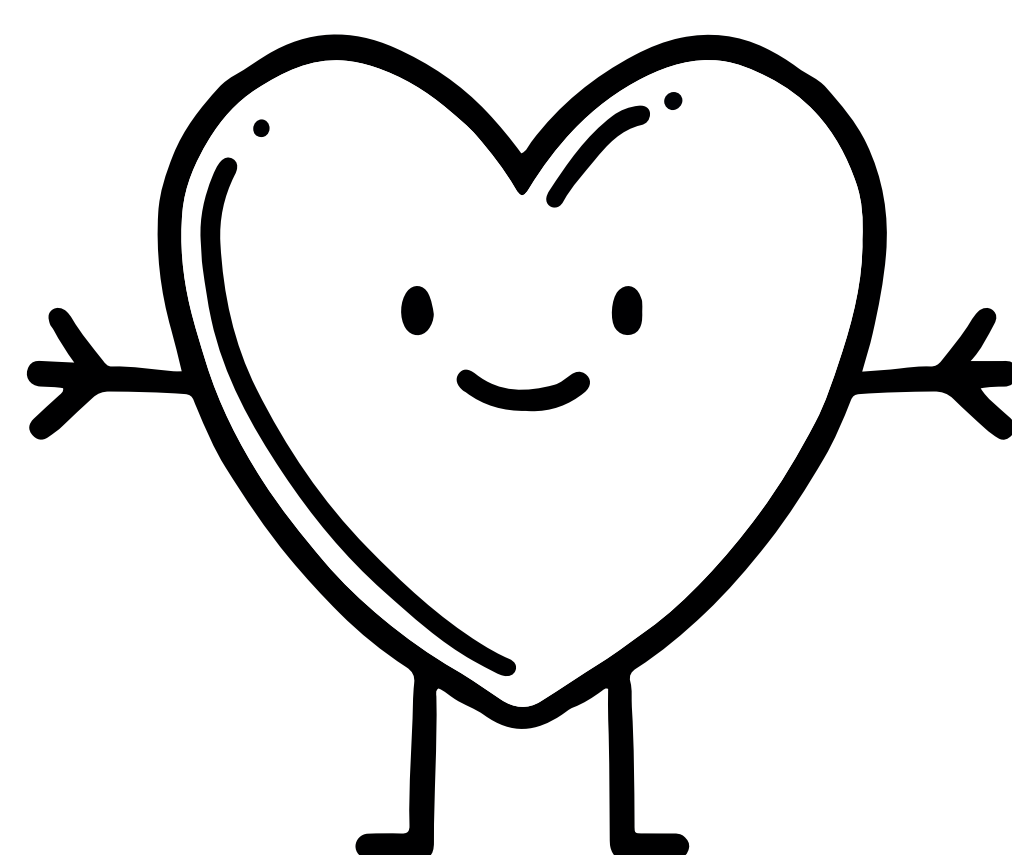
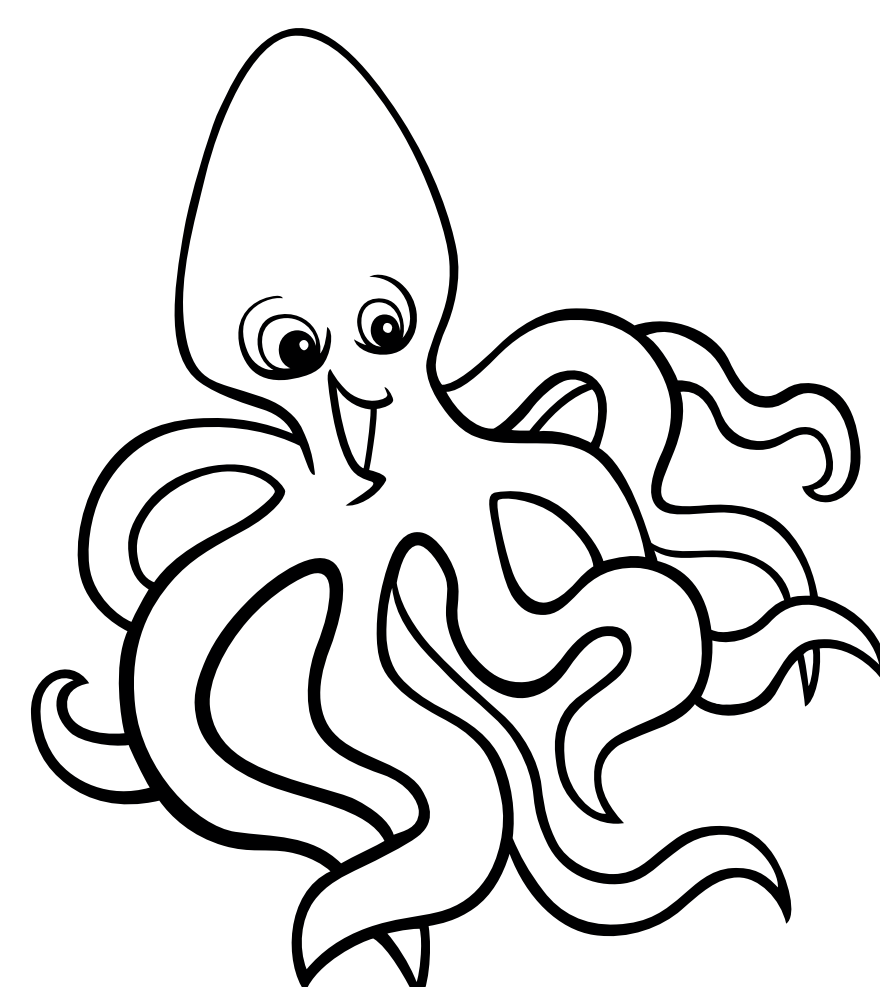
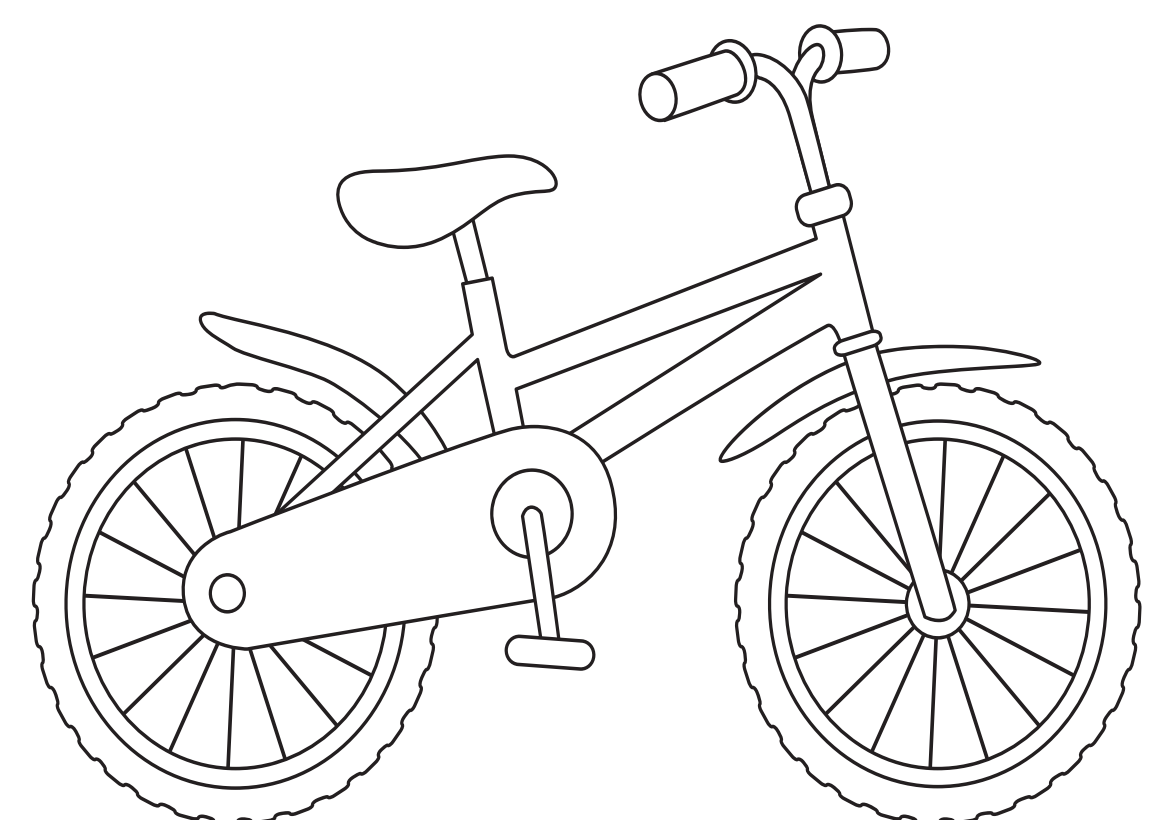
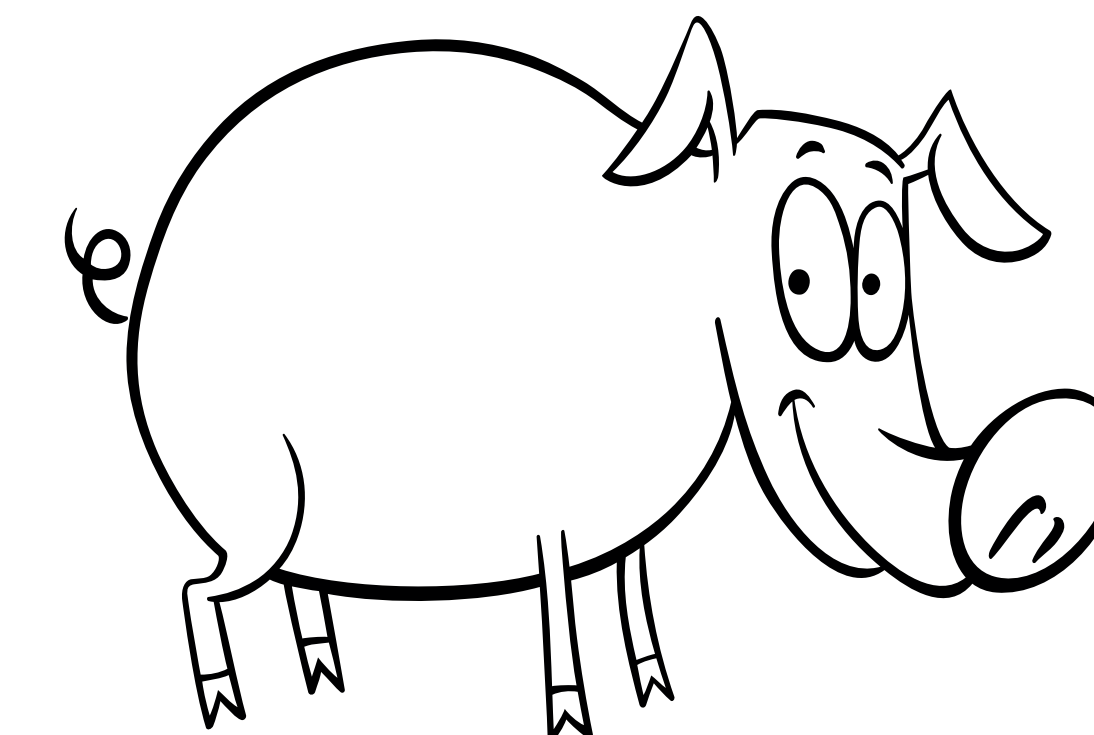
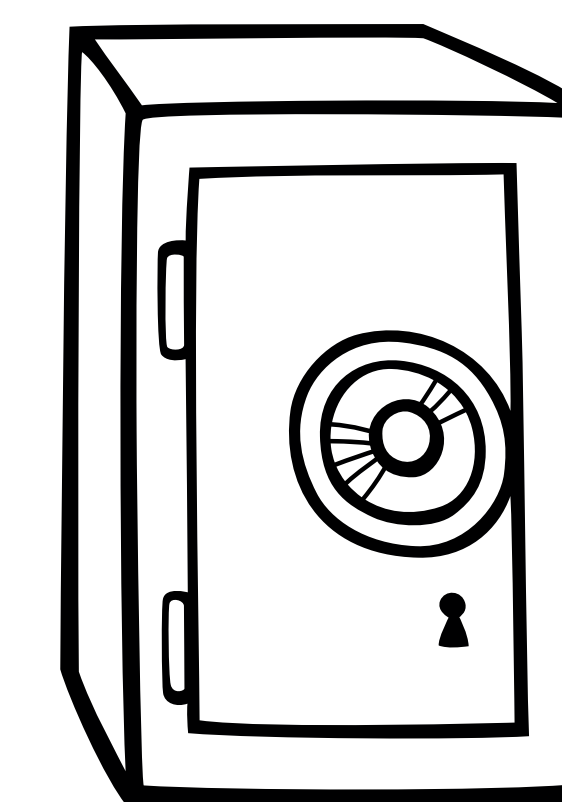
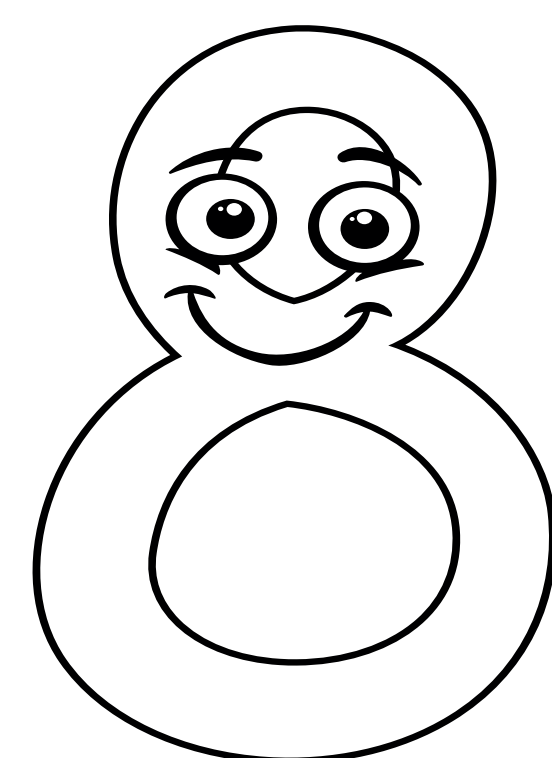
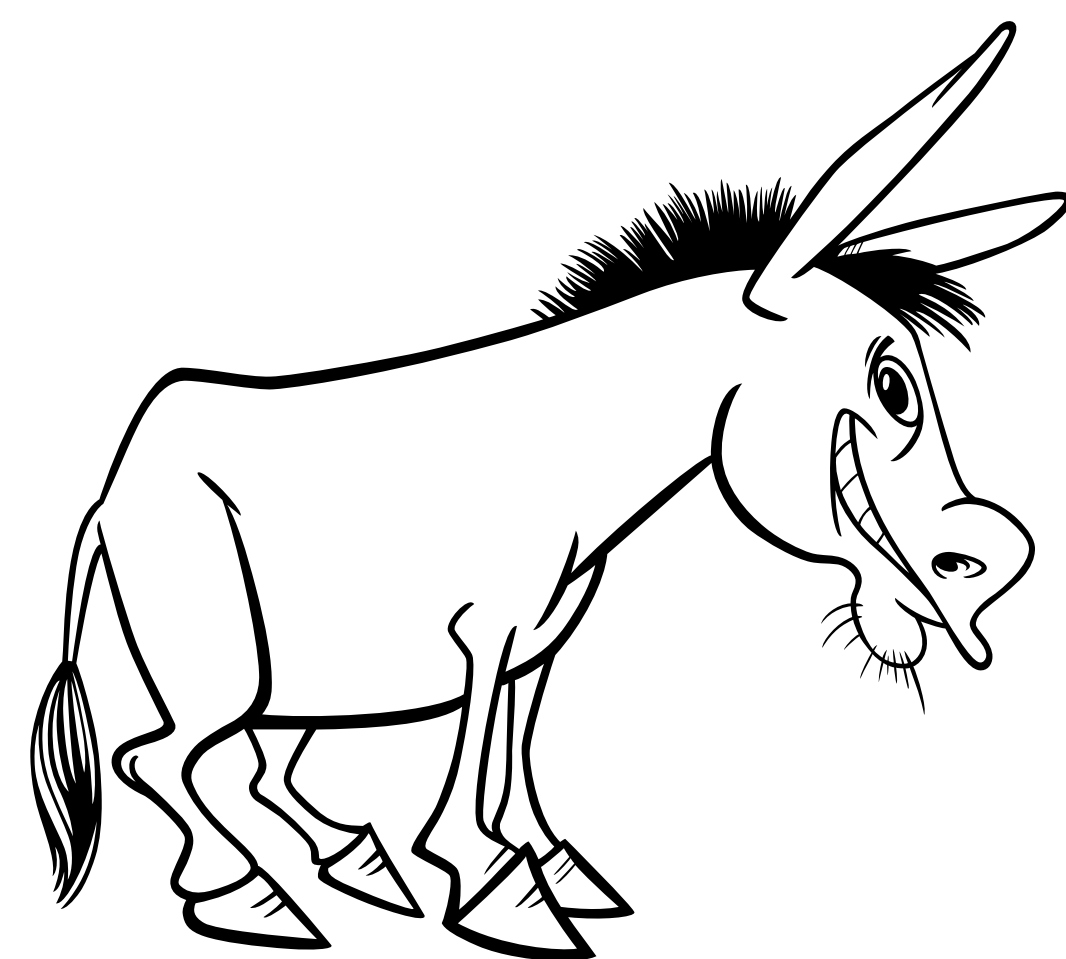
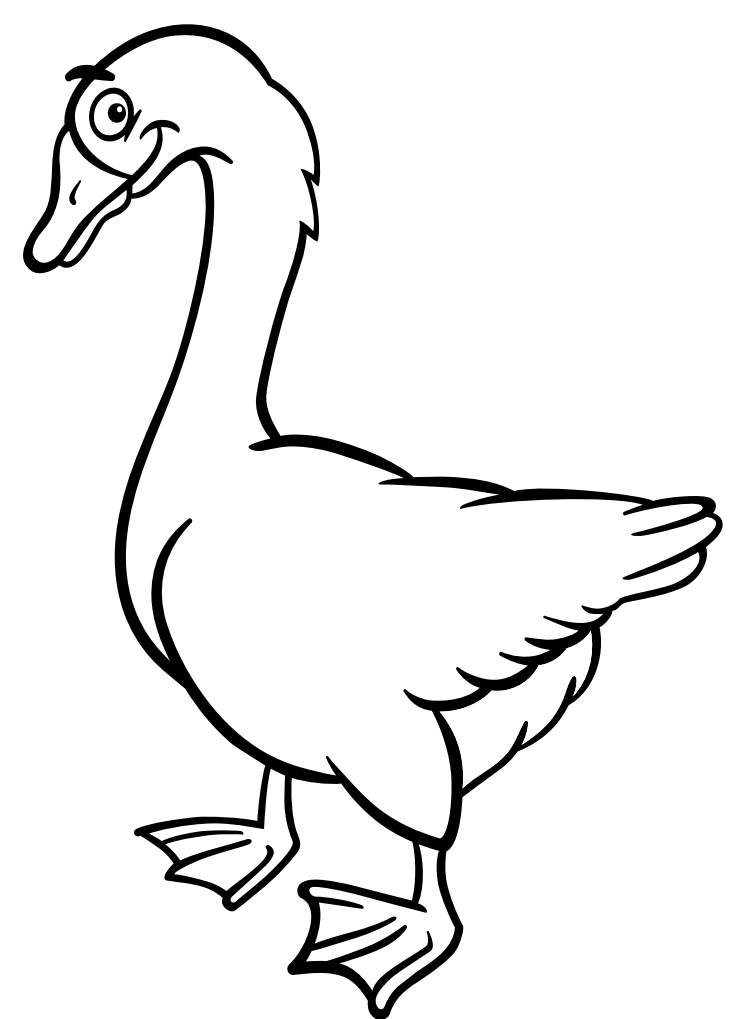

deti-i-mama.ru

vini.by



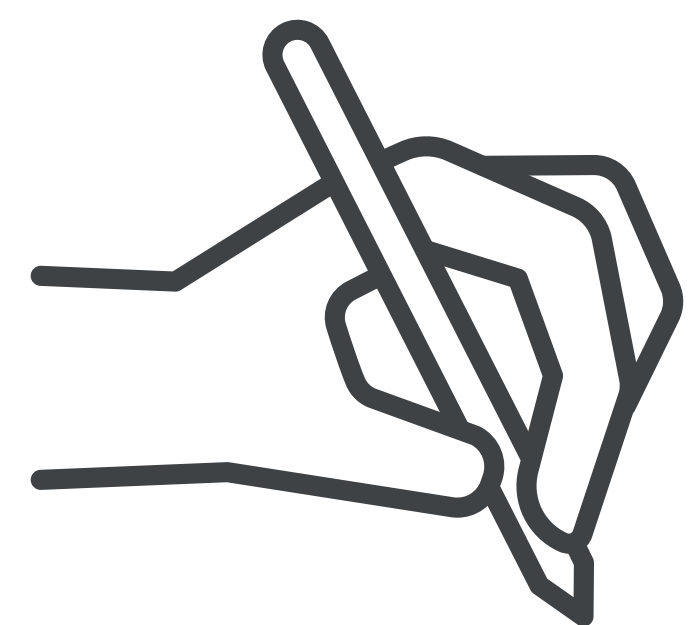

левая рука

Найди и назови одинаковые картинки слева и справа. Обведи их двумя руками одновременно

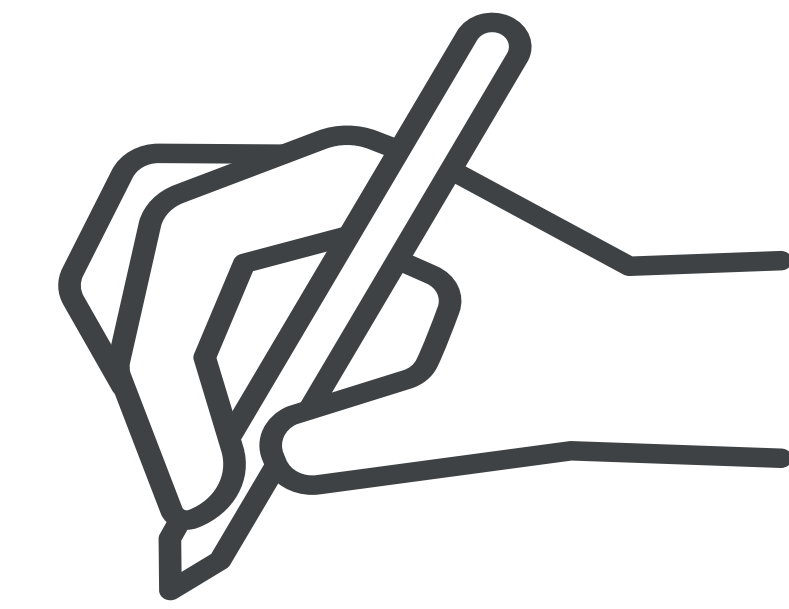

правая рука

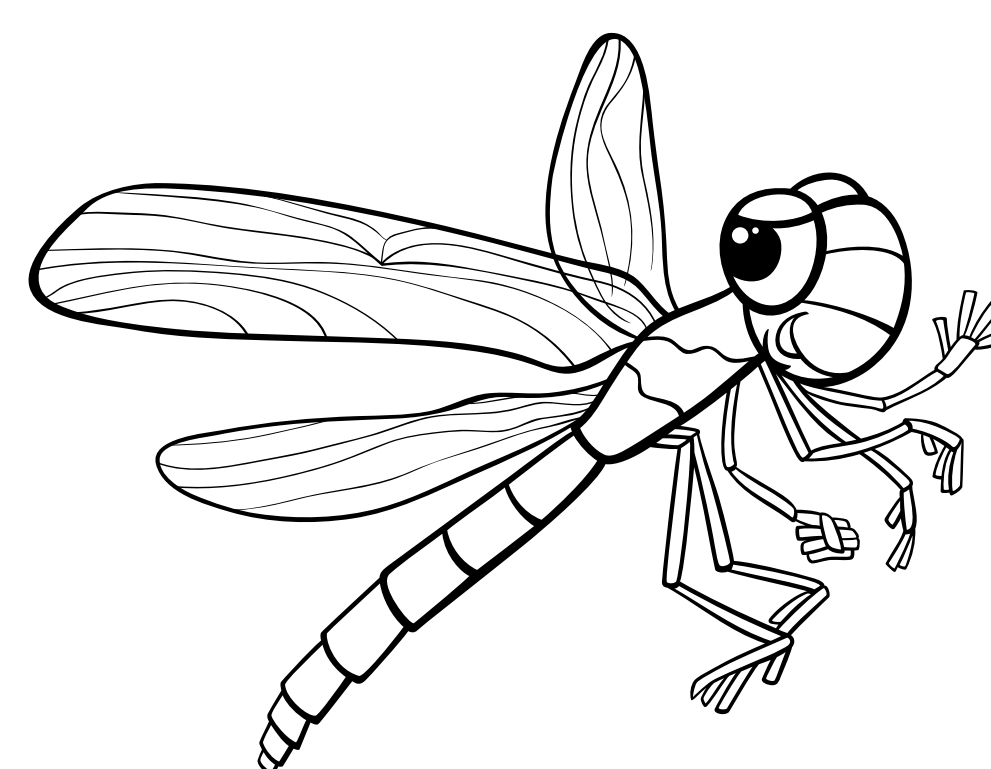
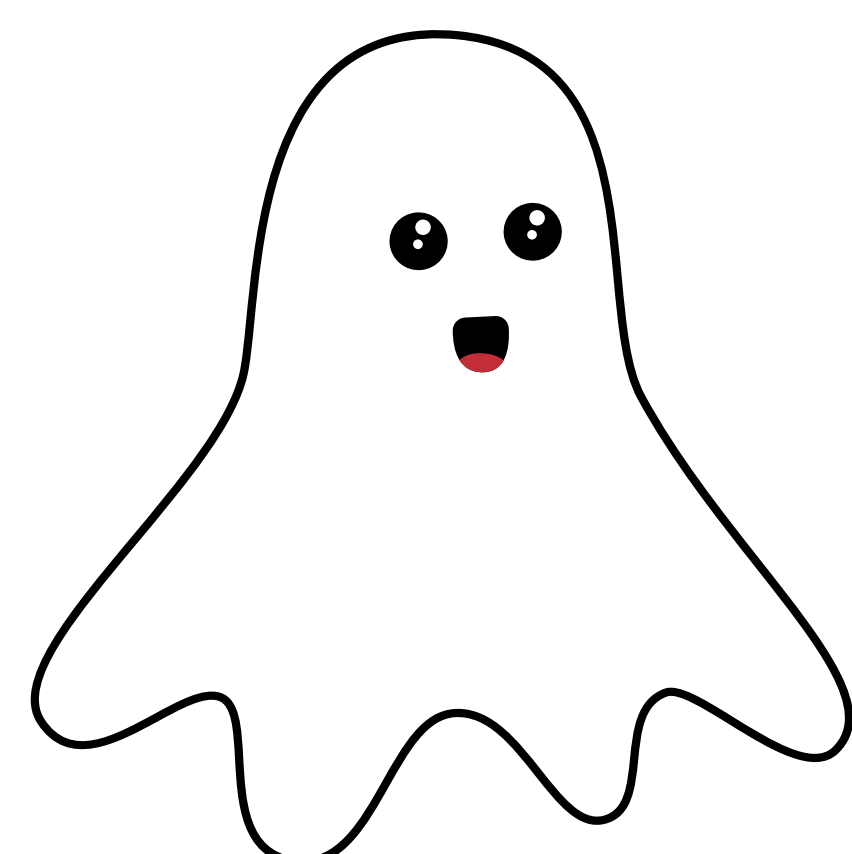
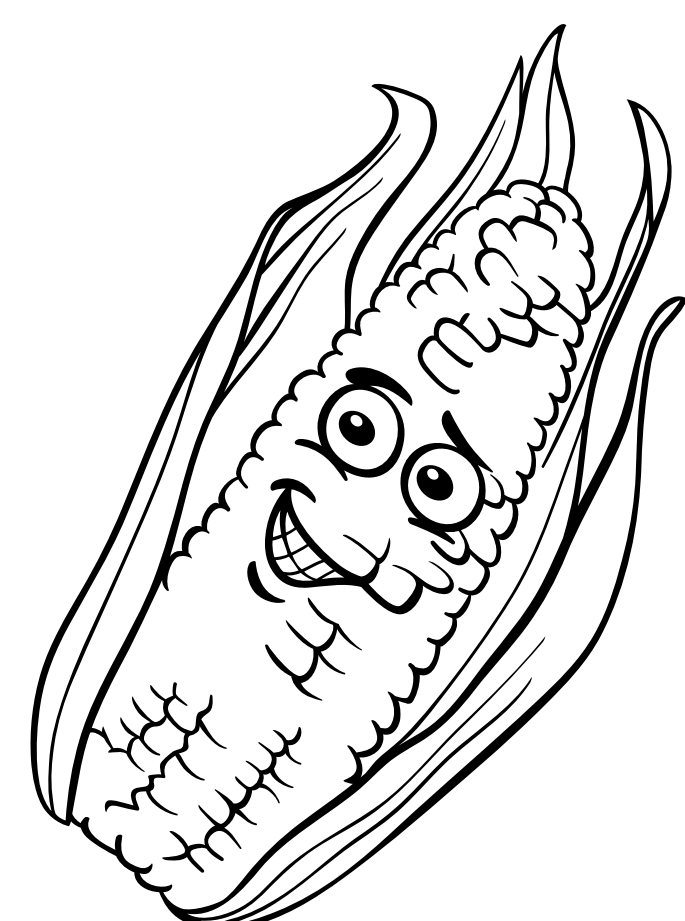
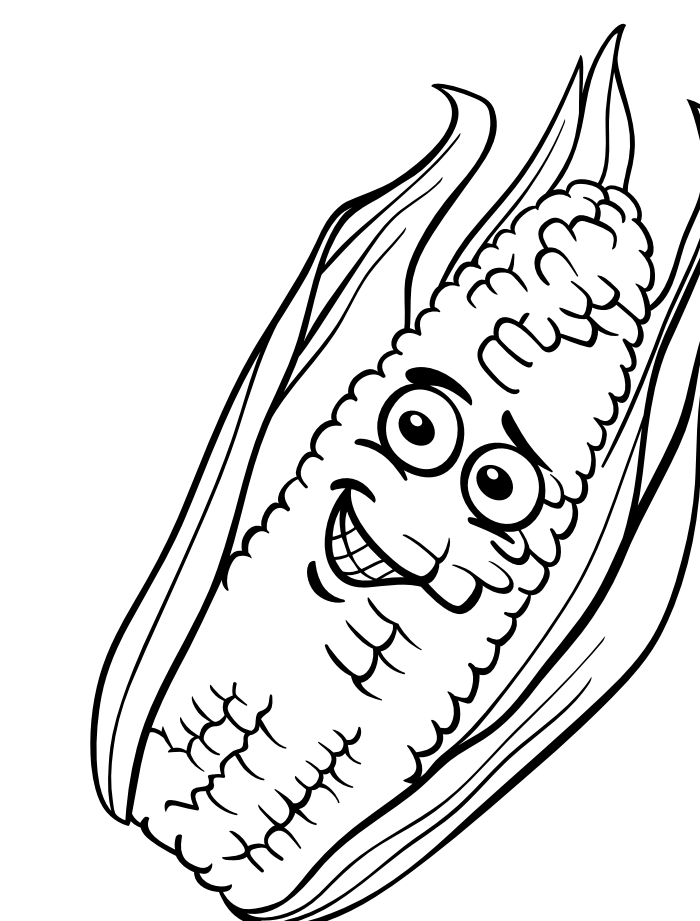
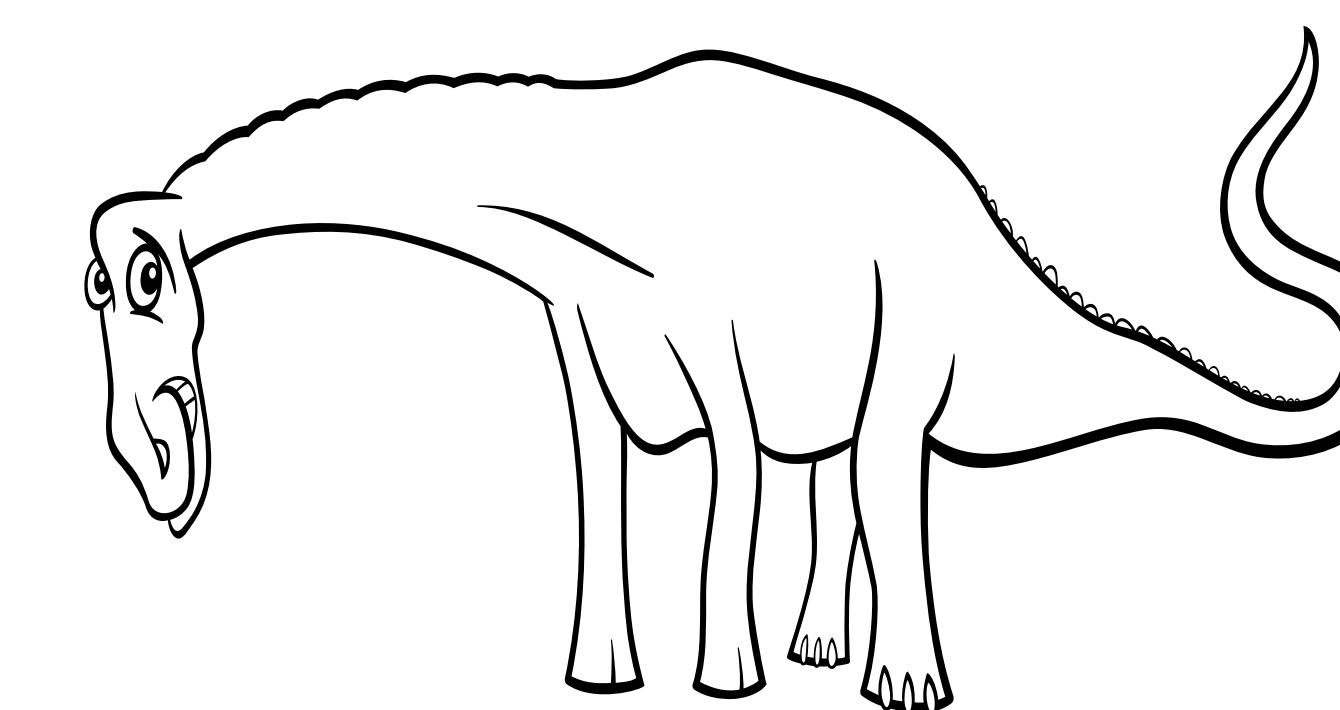
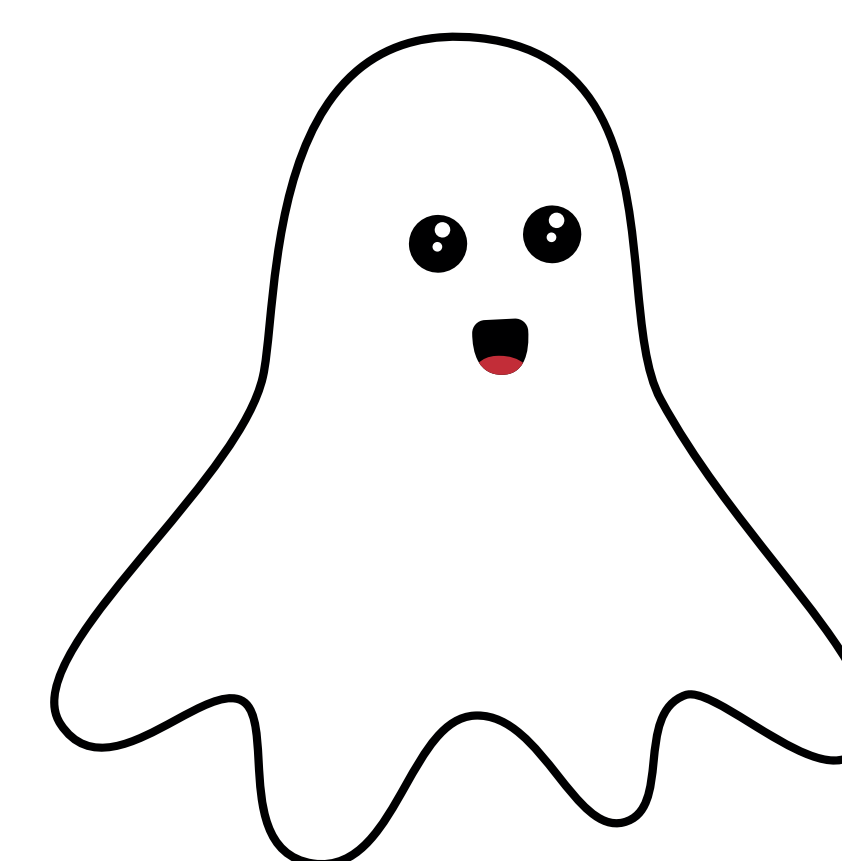
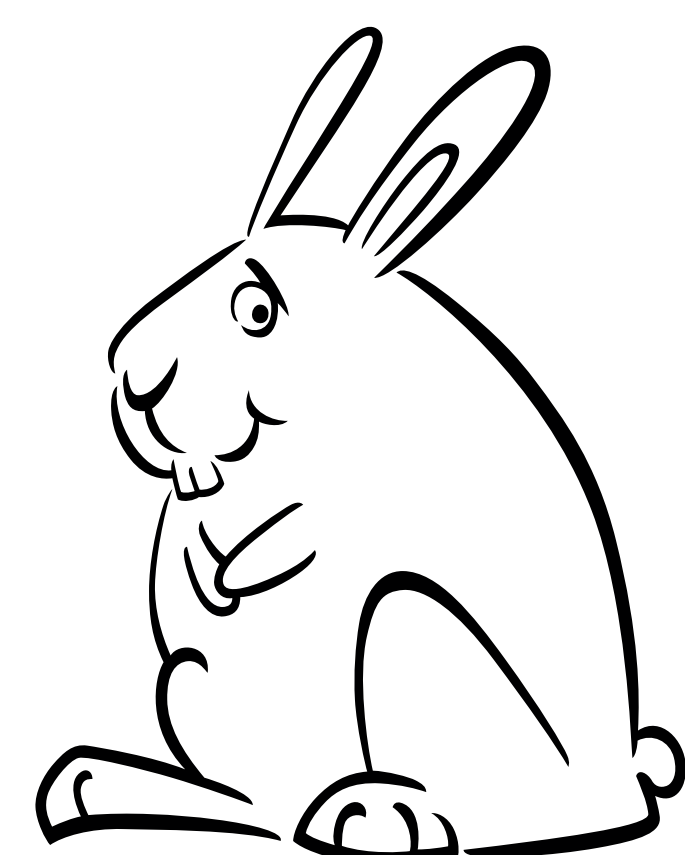
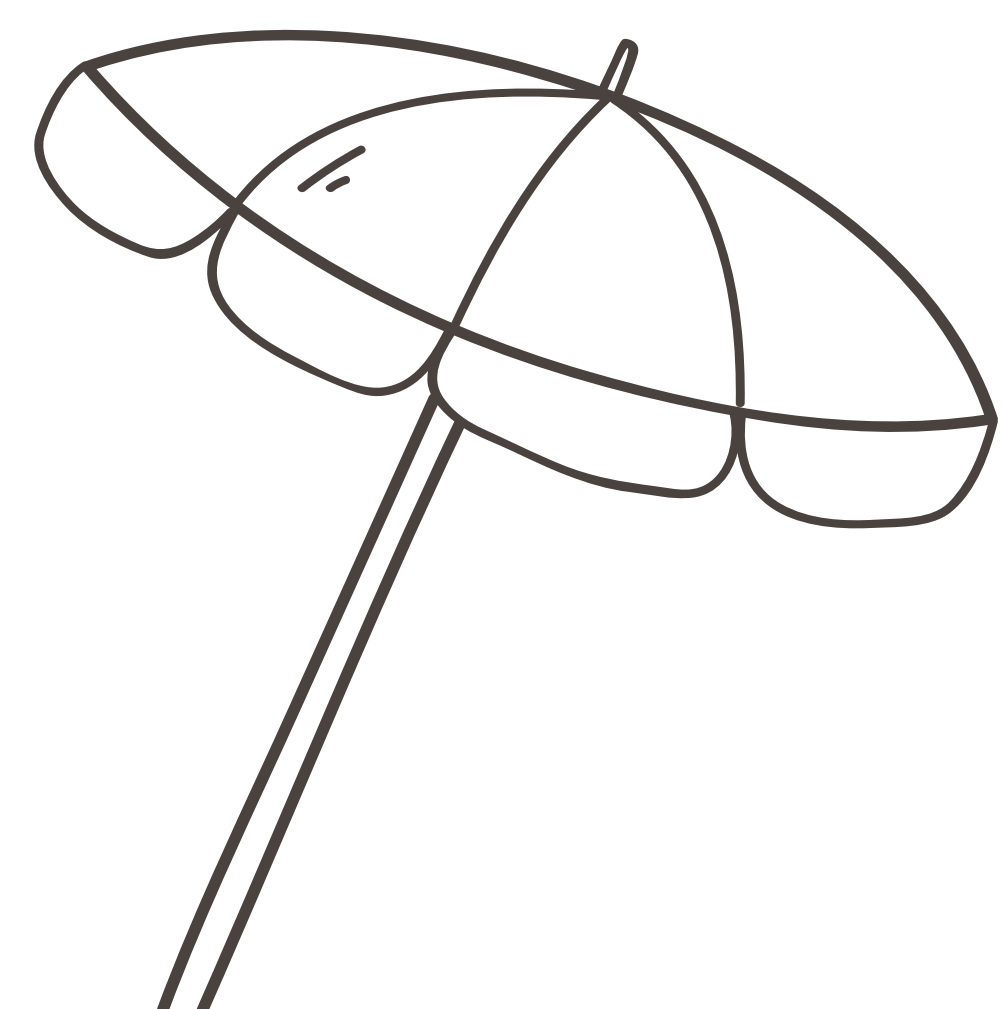
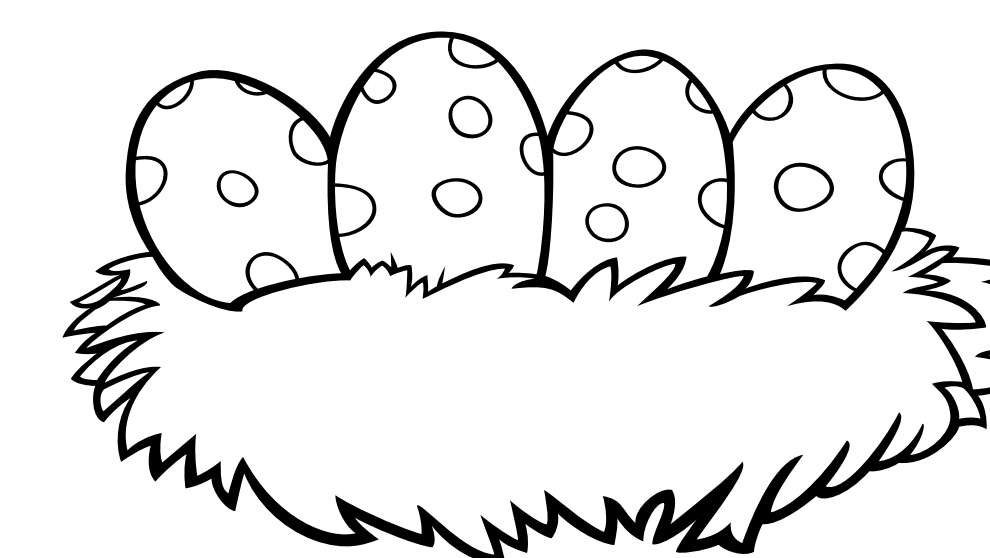
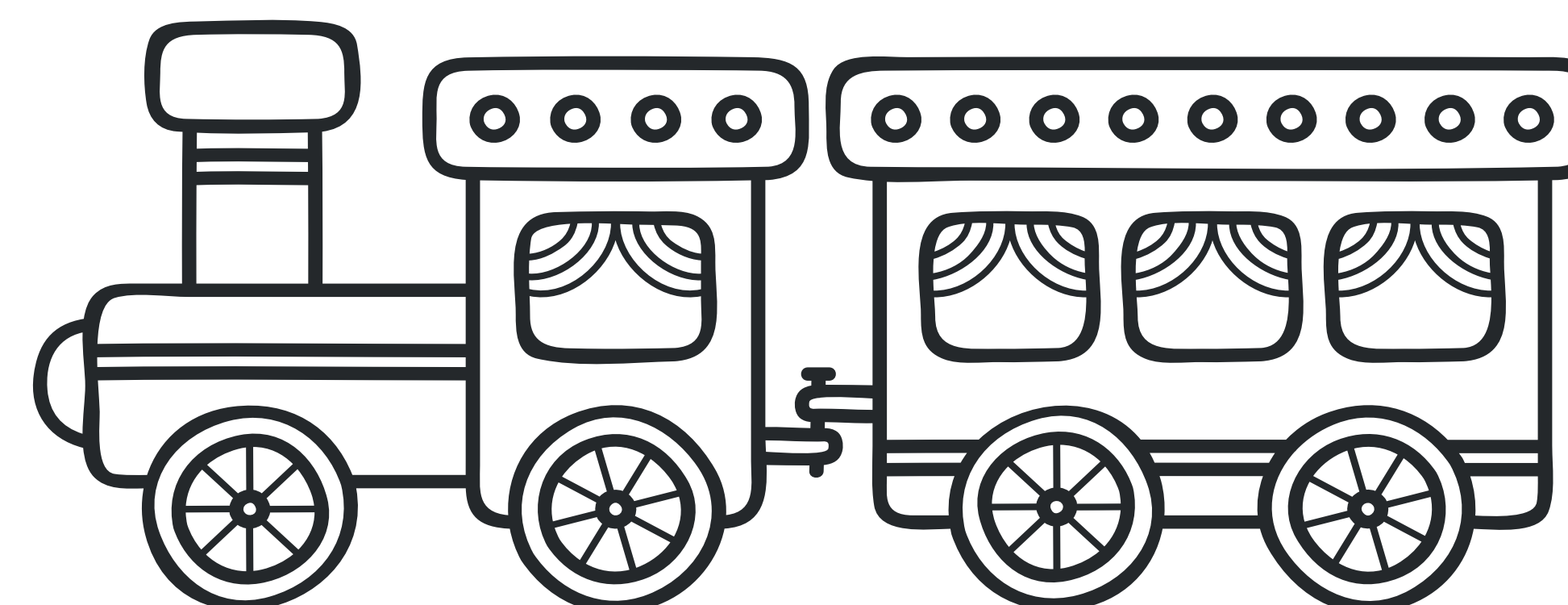
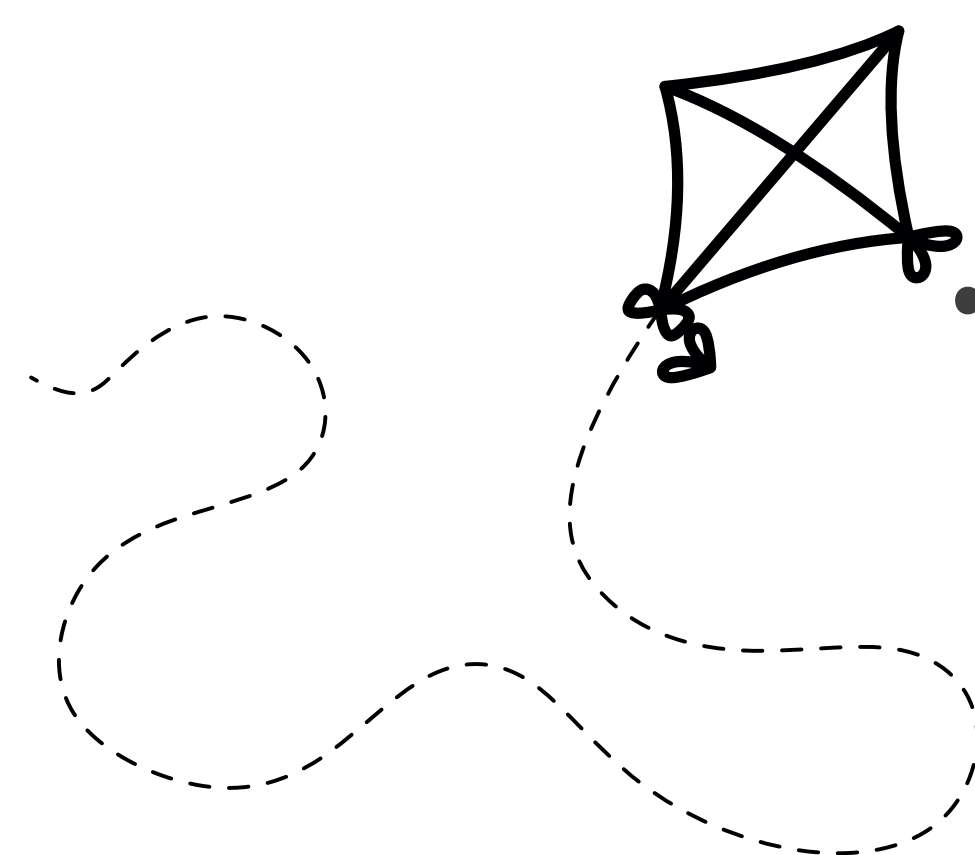
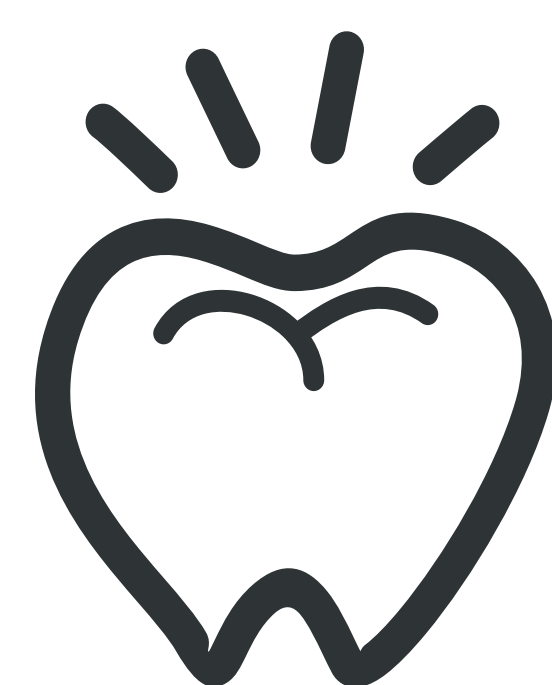
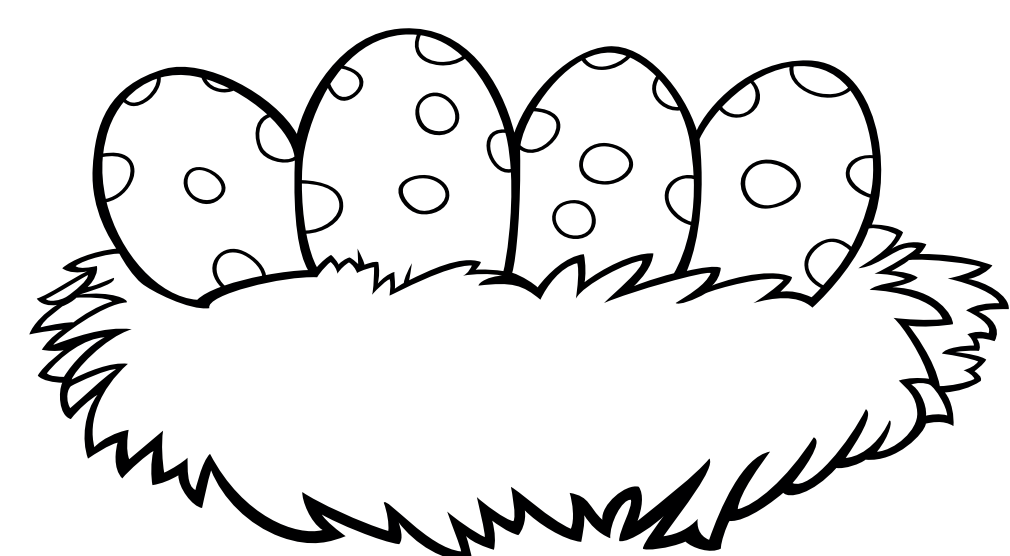
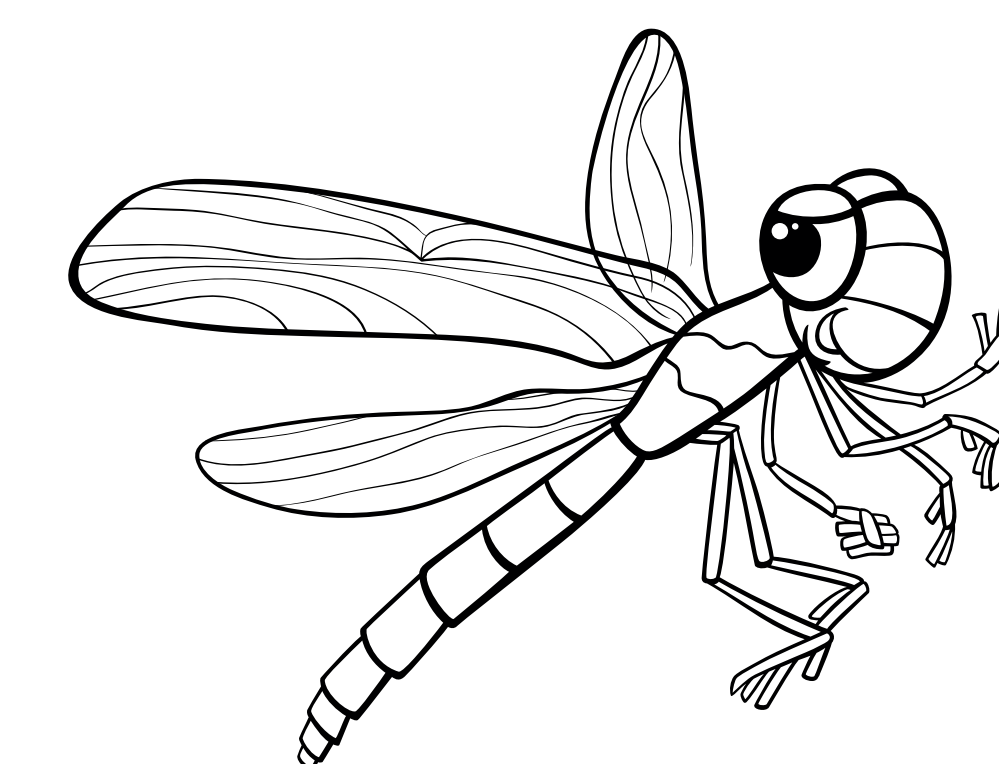
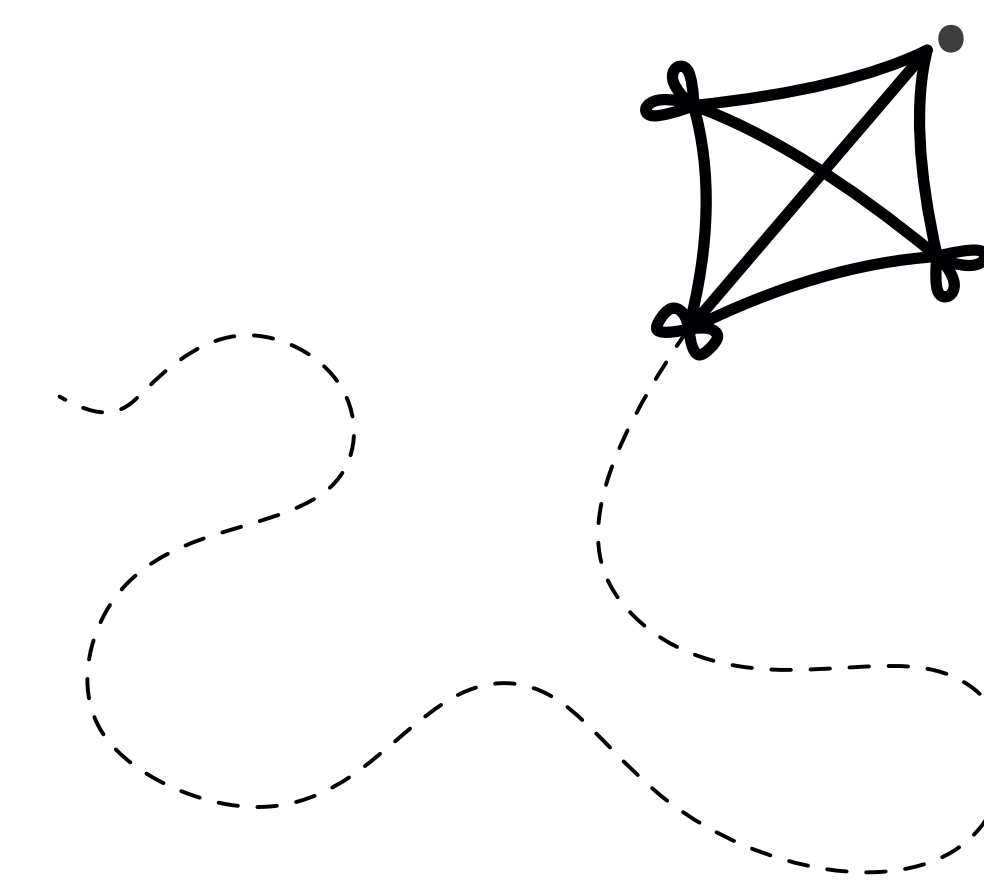
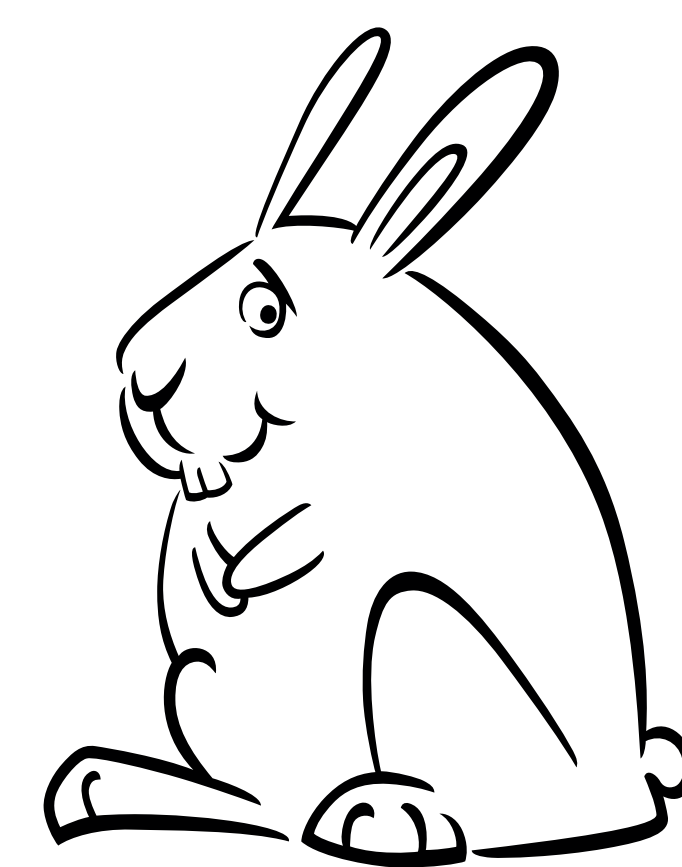
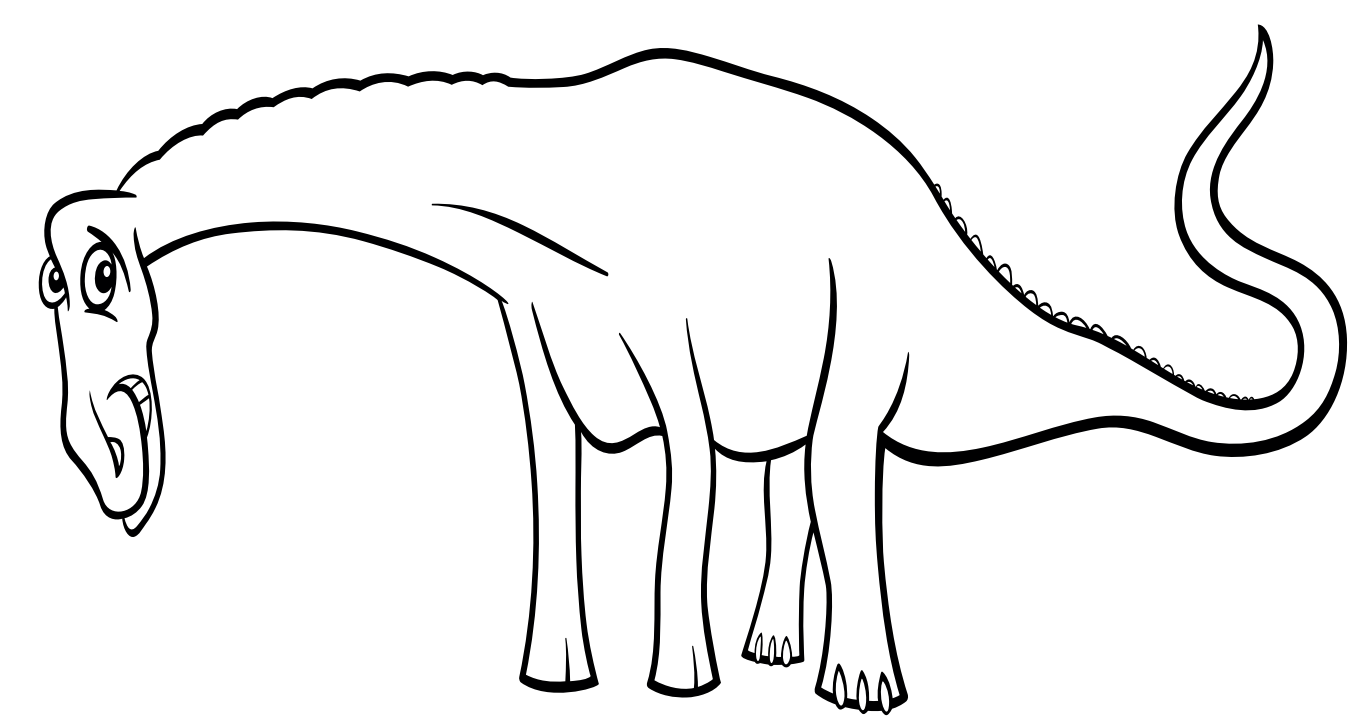
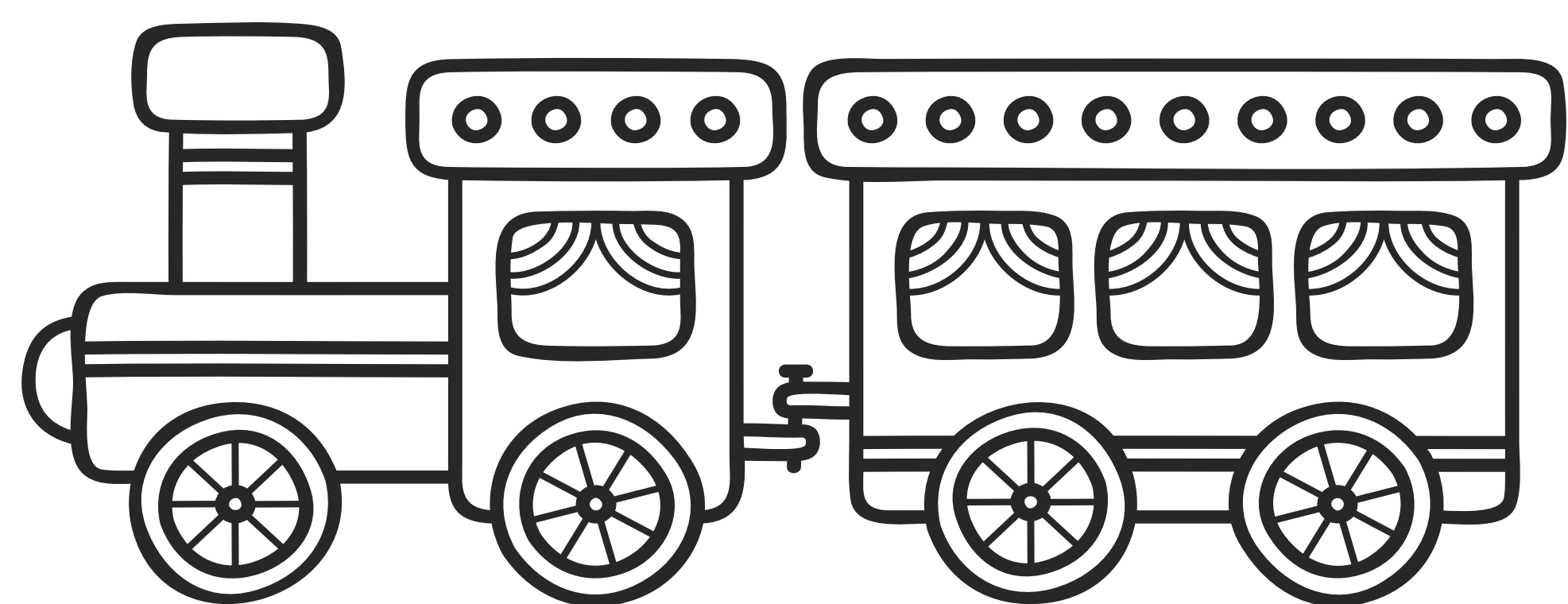



3'

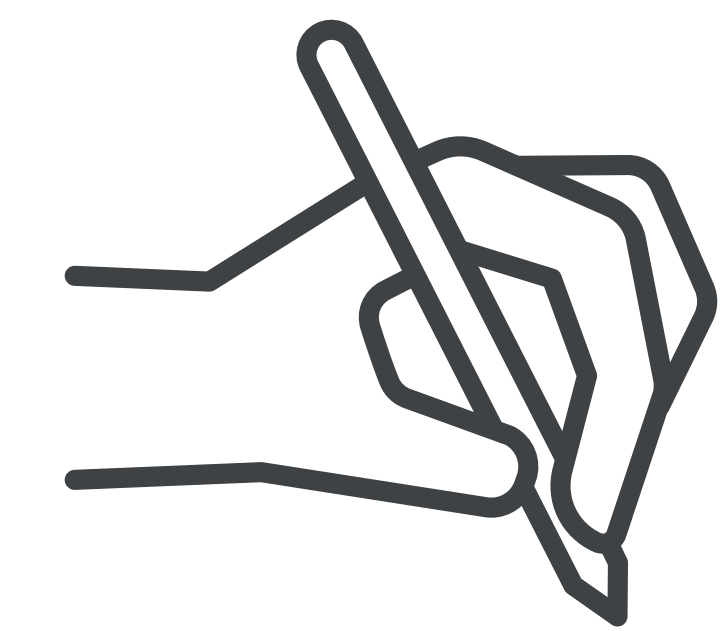

левая рука

Найди и назови одинаковые картинке слева и справа. Обведи их двумя руками одновременно

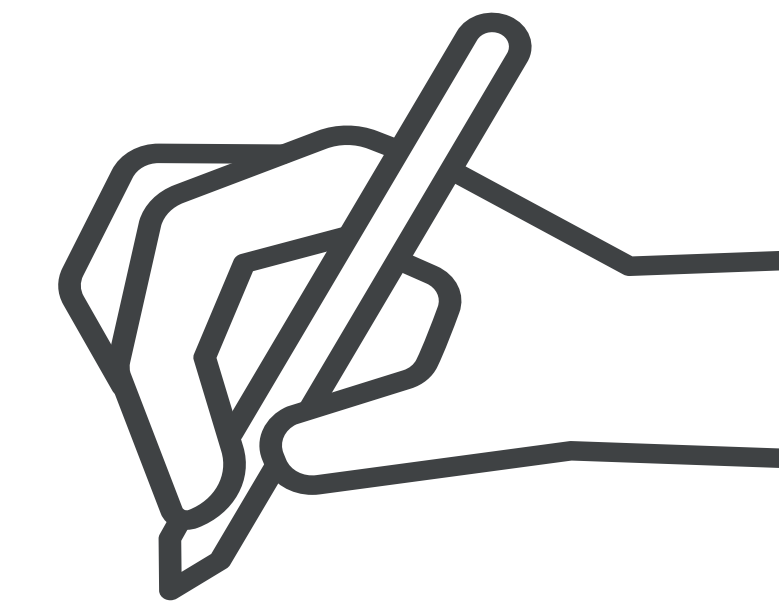

правая рука

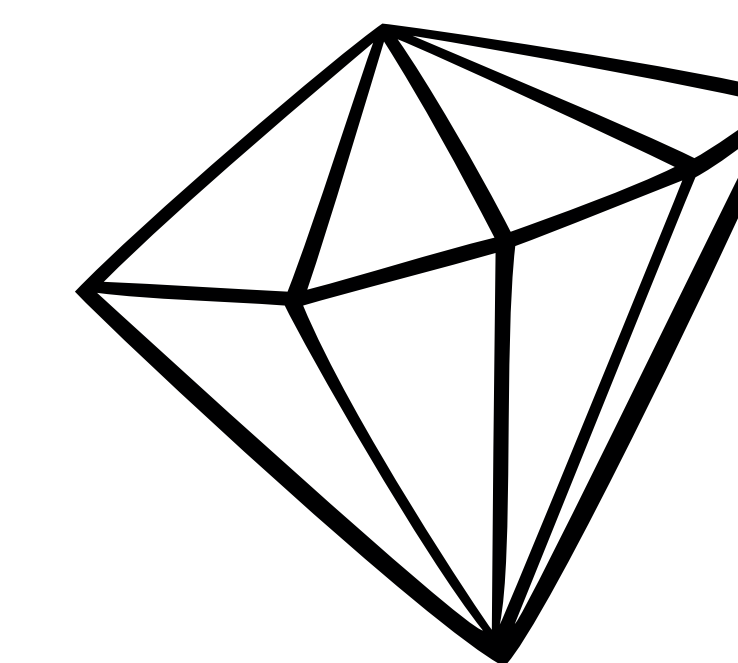
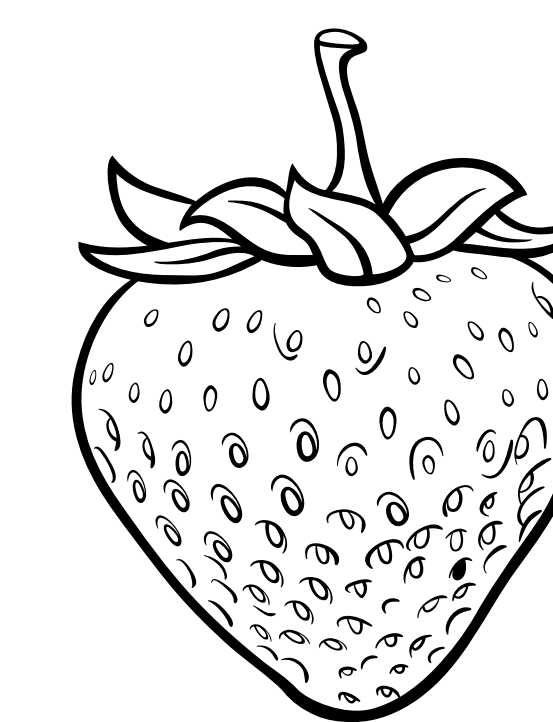
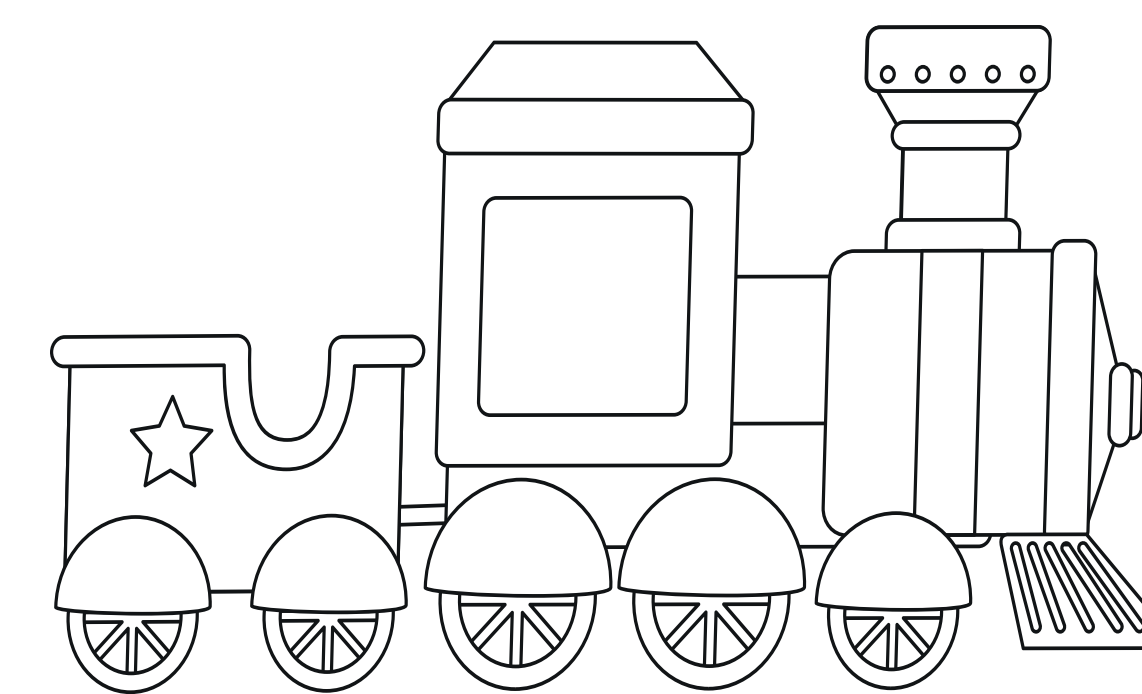
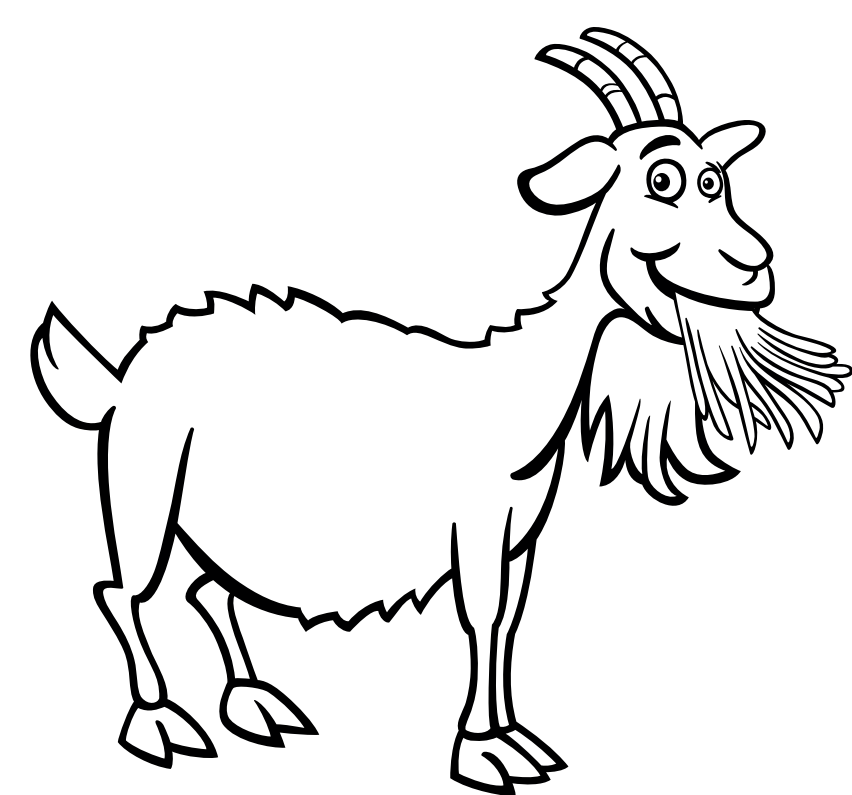
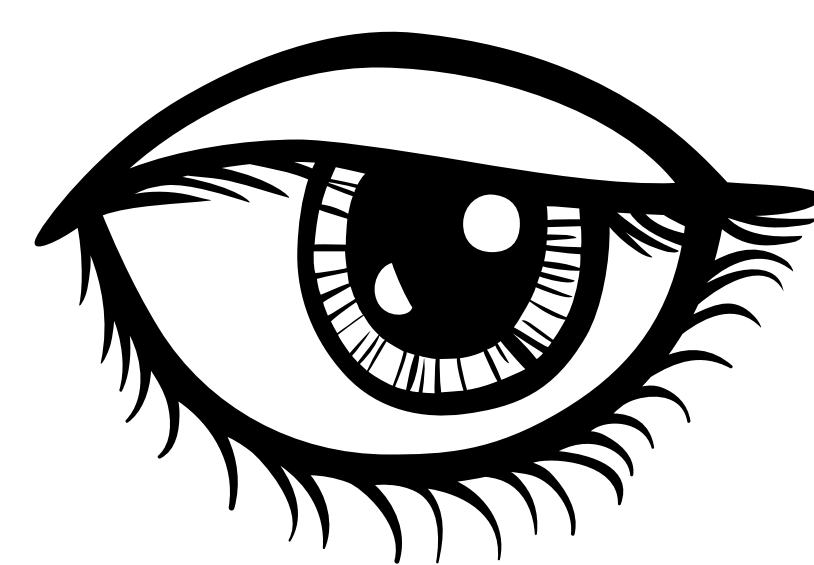
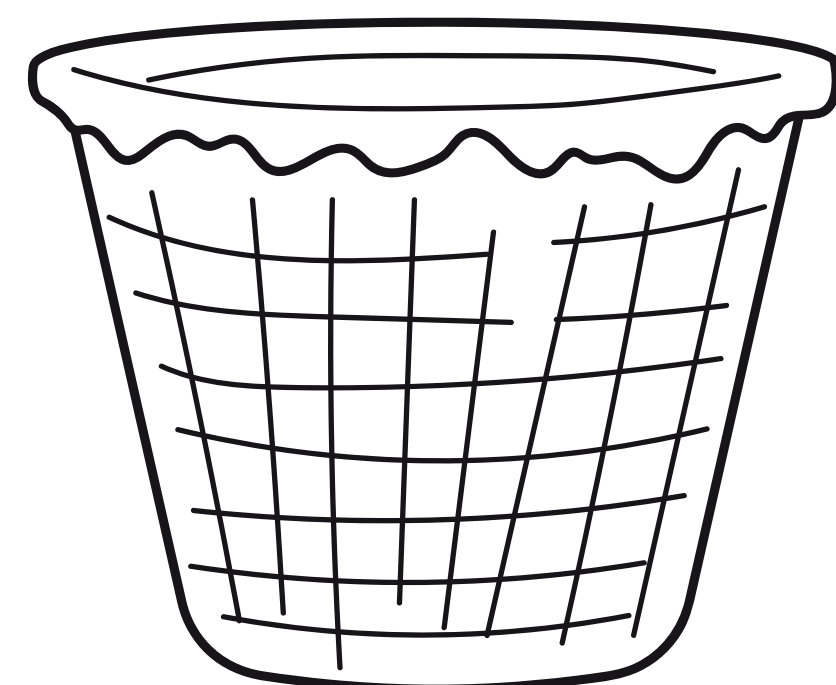
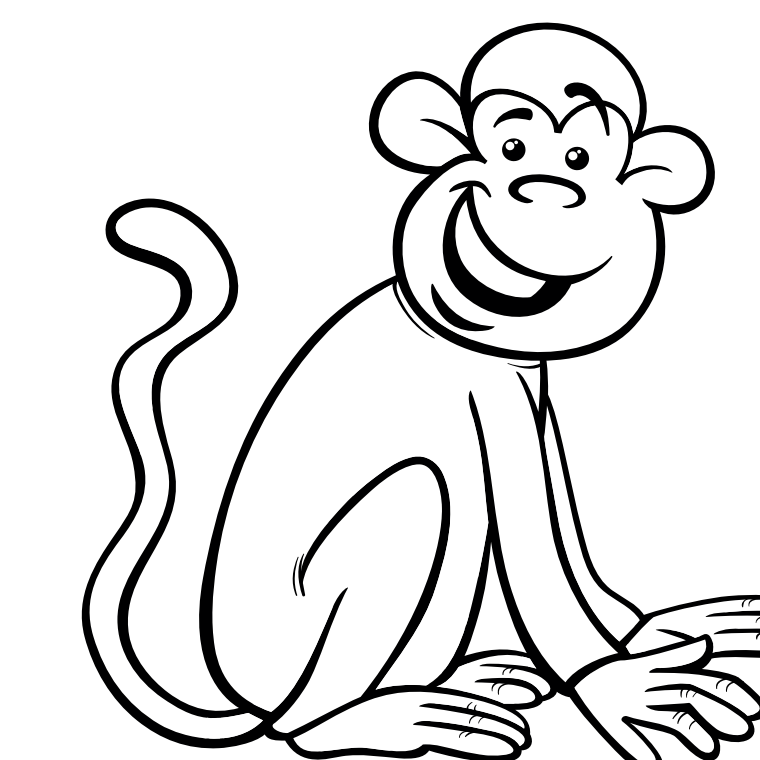
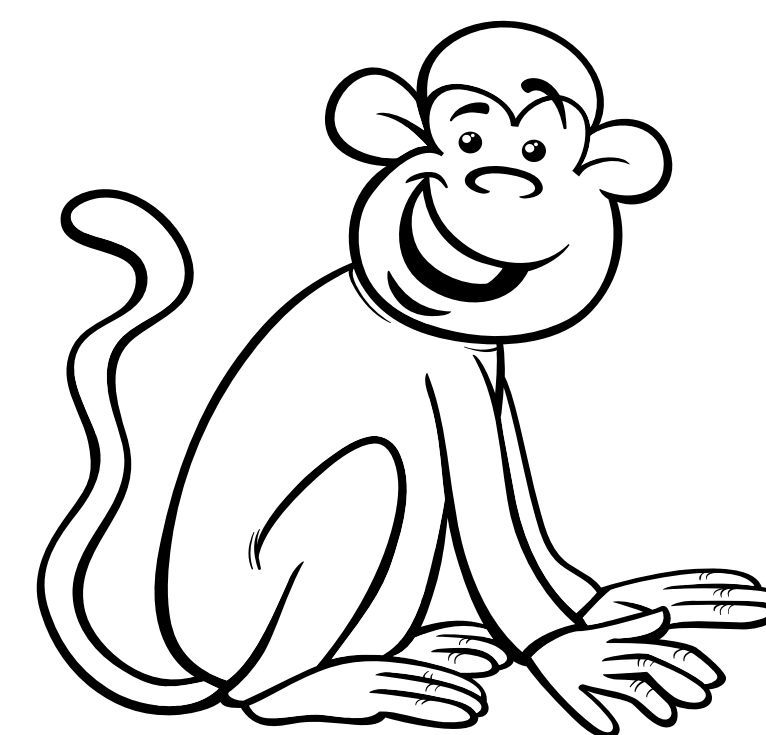
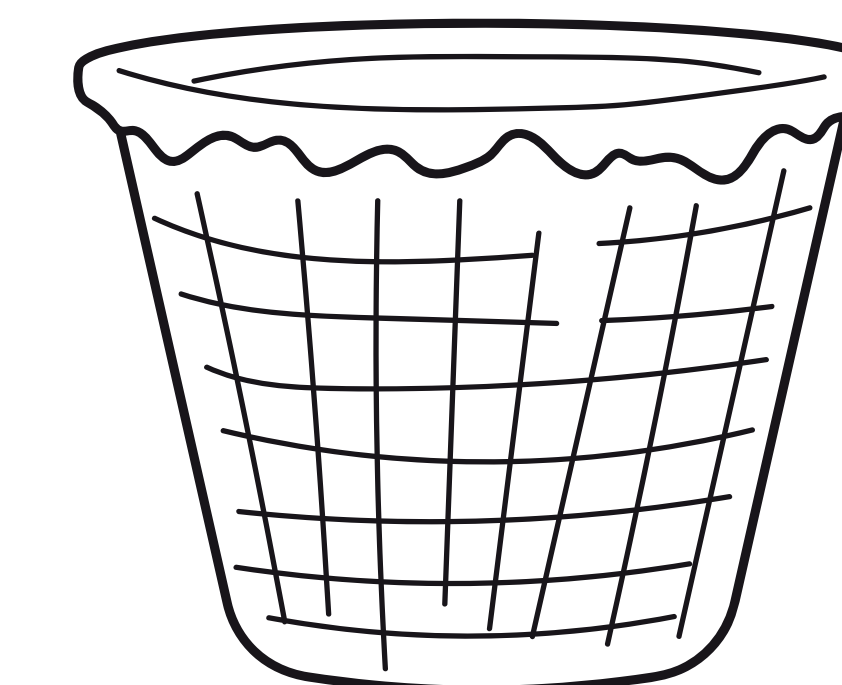
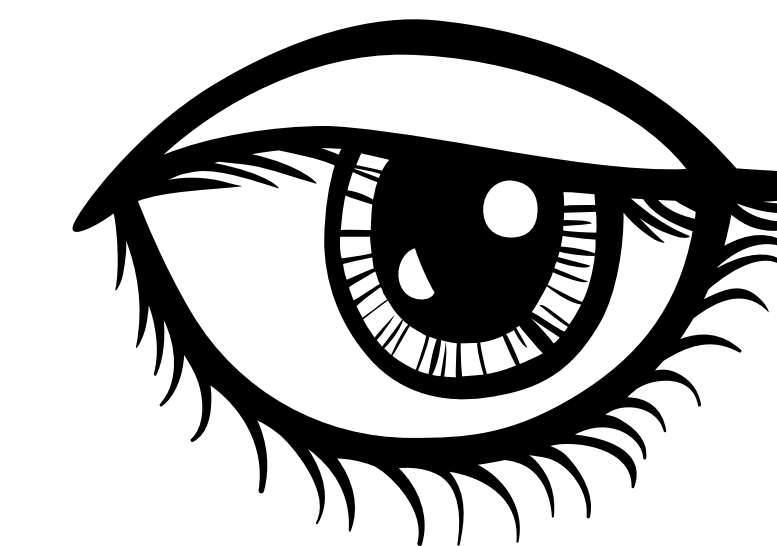
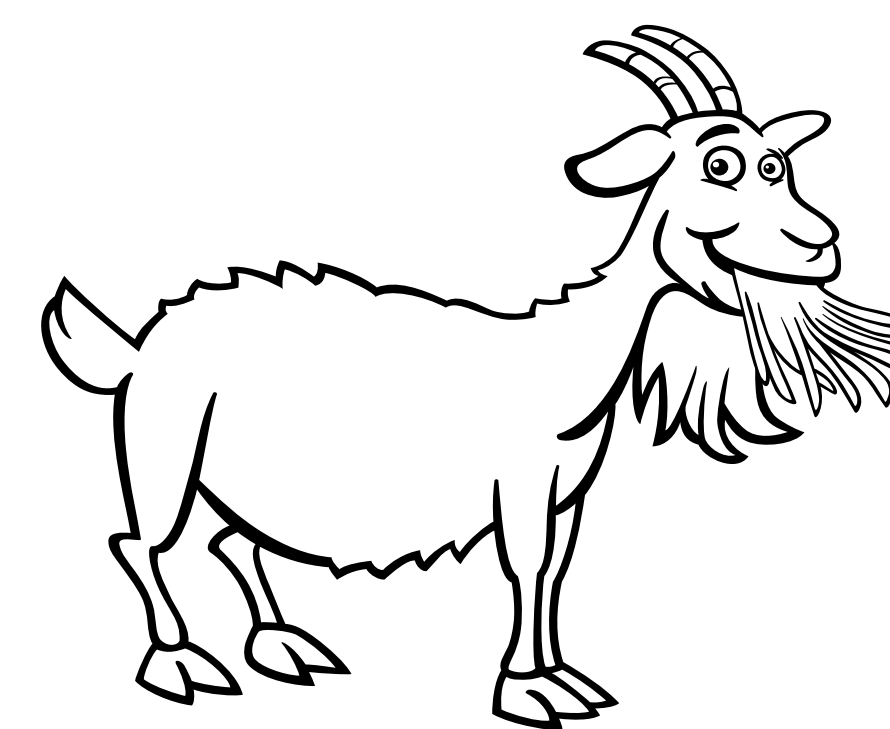
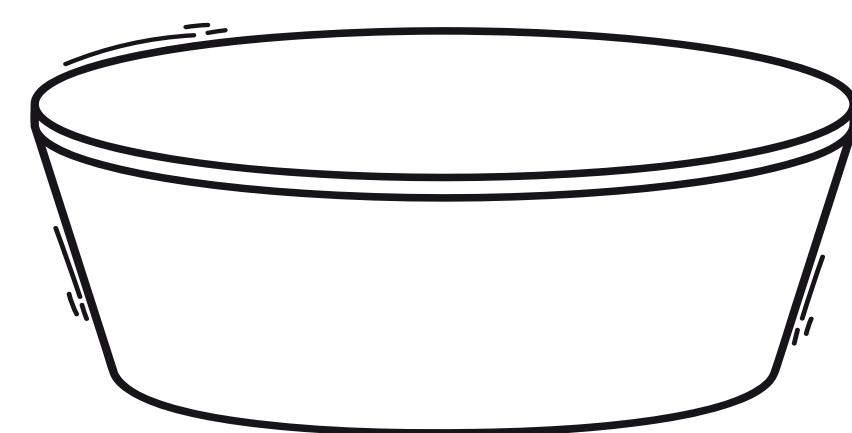
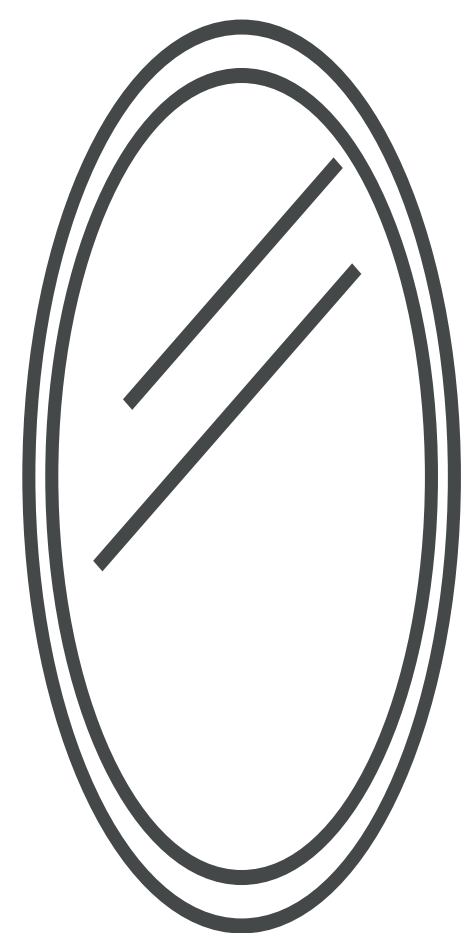
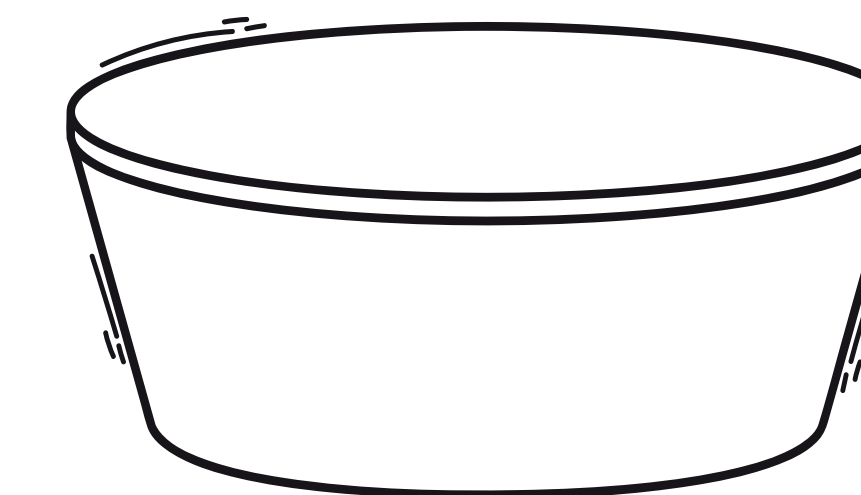
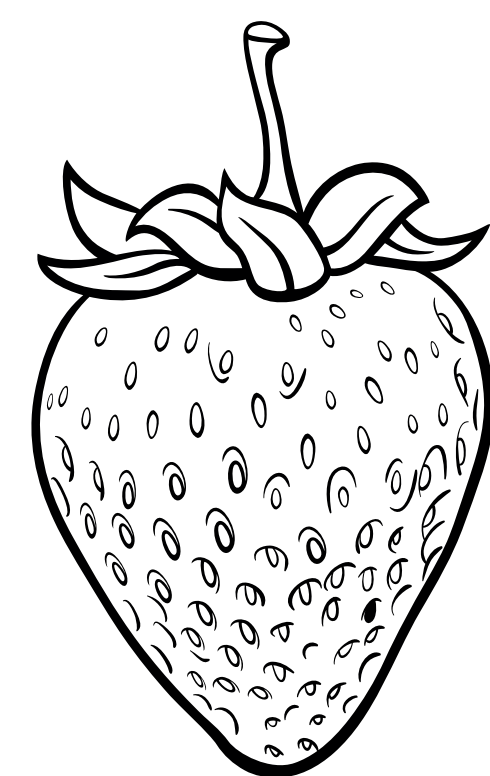
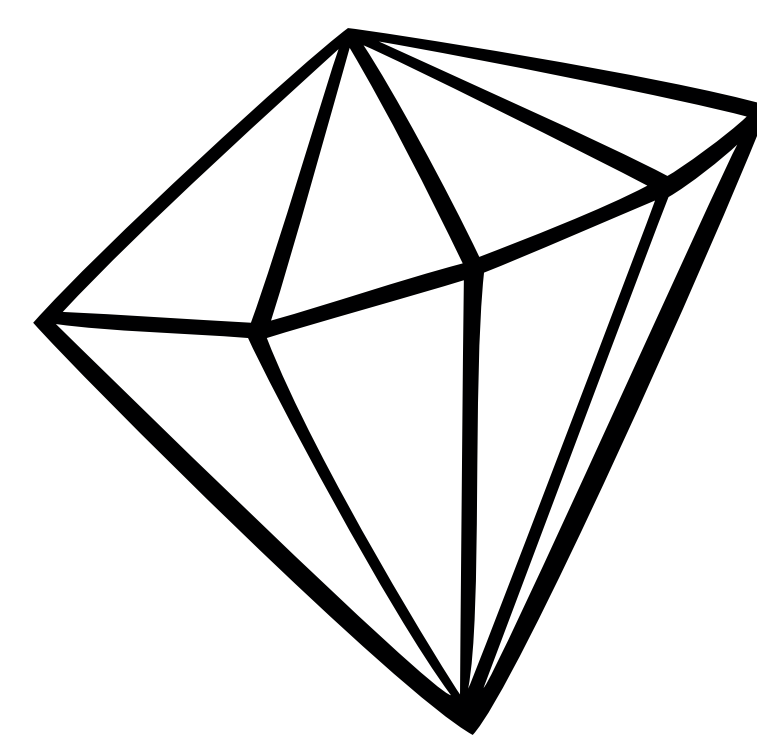
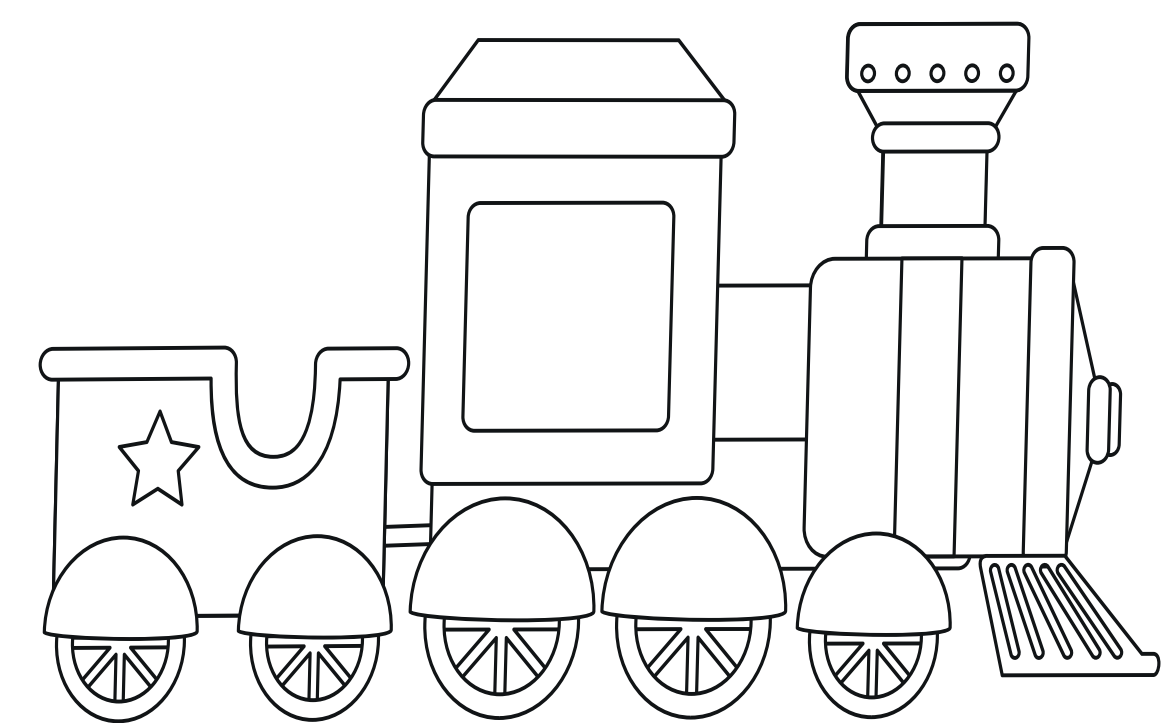

deti-i-mama.ru

vini.by



Ц

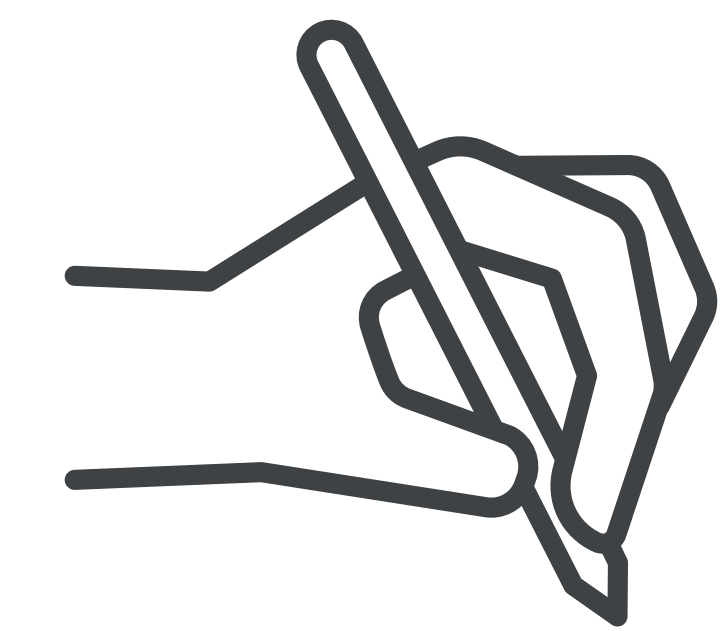

левая рука

Найди и назови одинаковые картинке слева и справа. Обведи их двумя руками одновременно

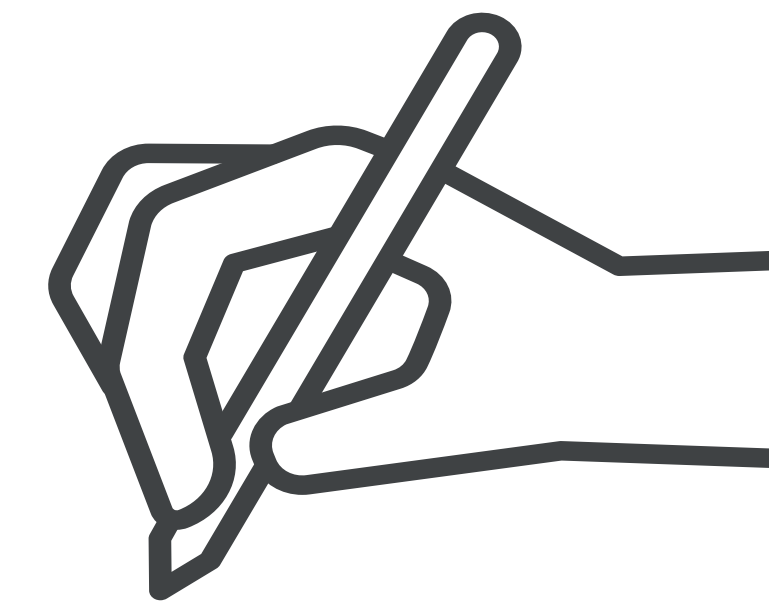

правая рука

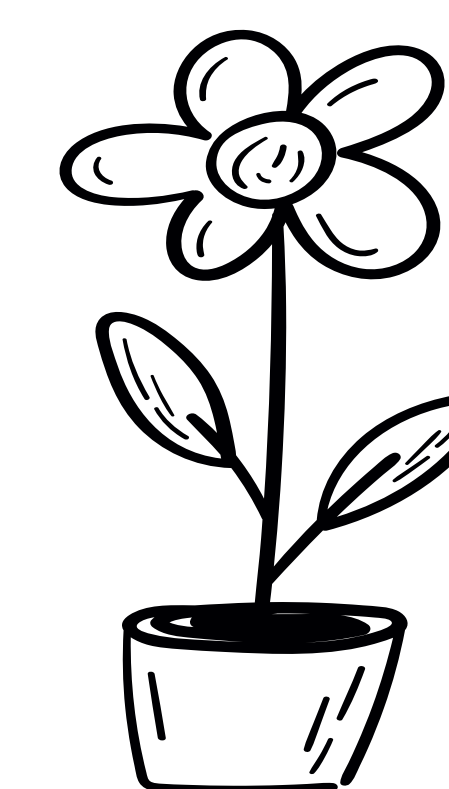
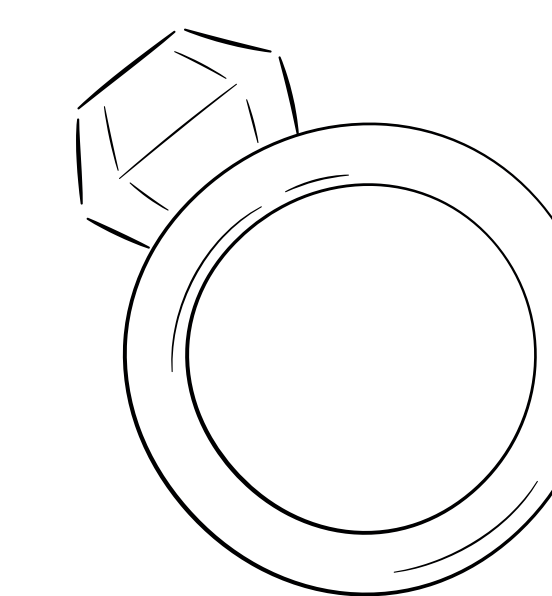
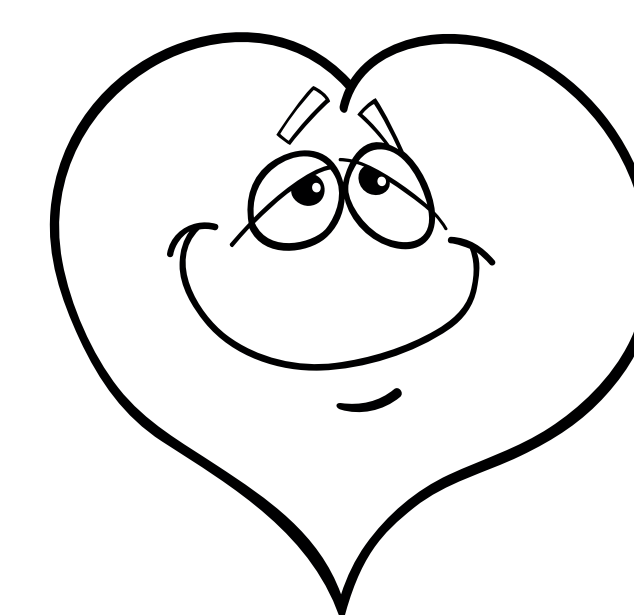
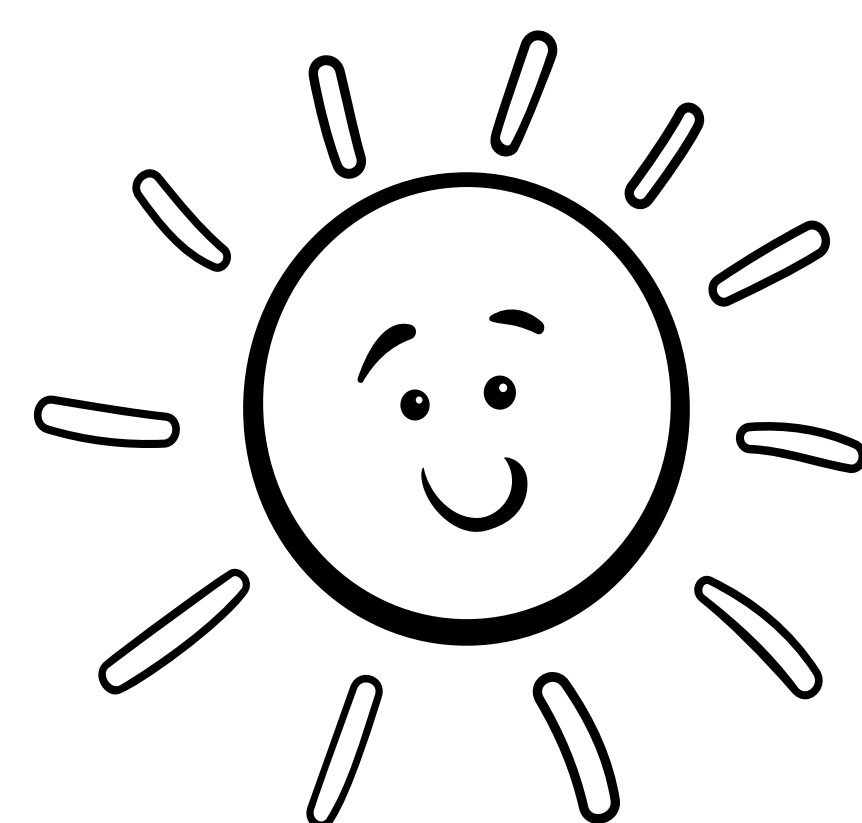
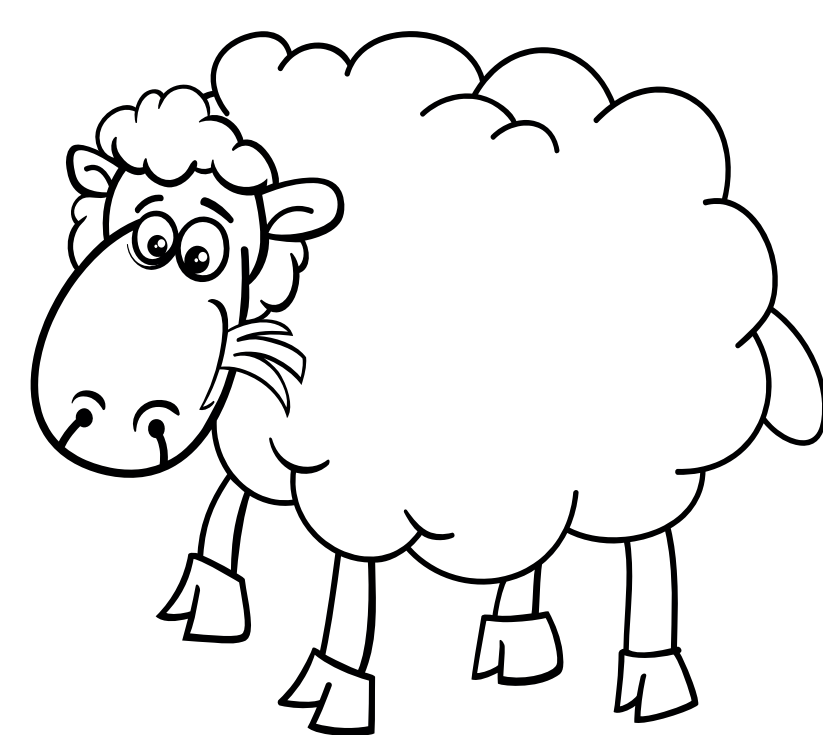
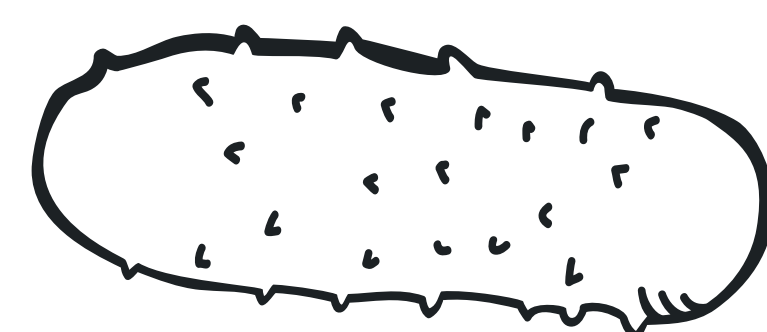
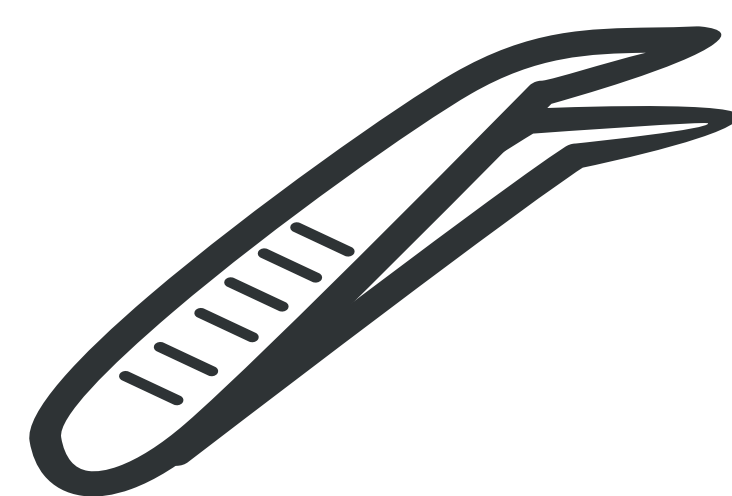
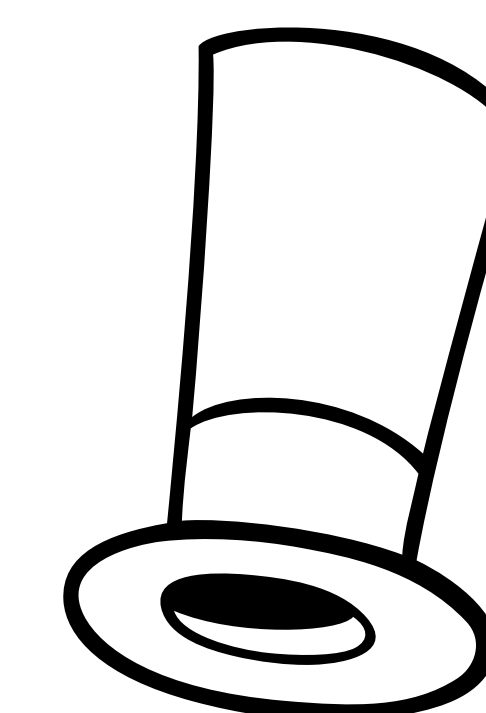
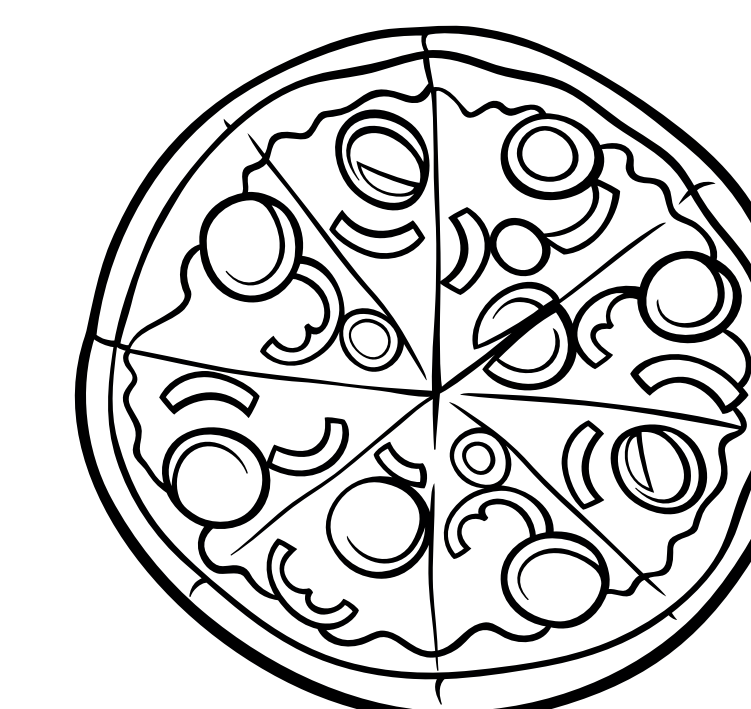
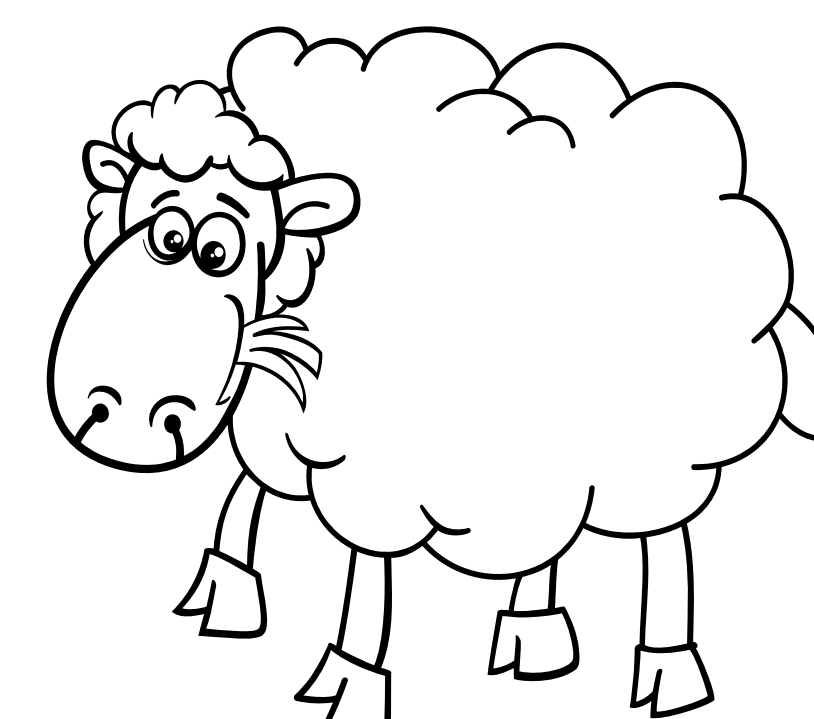
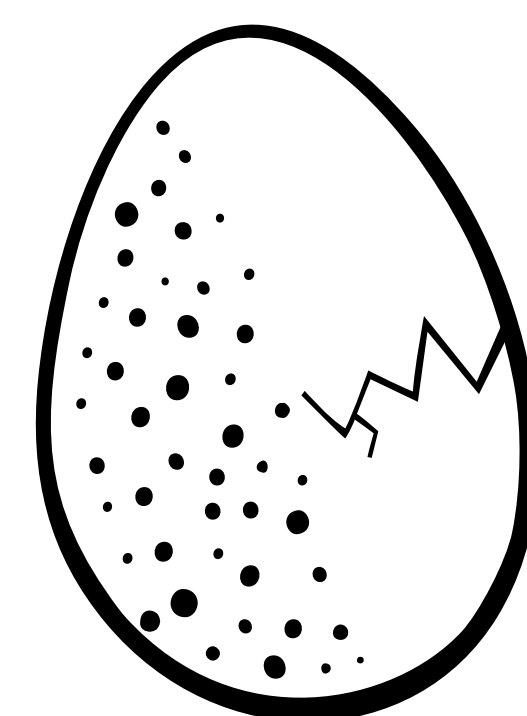
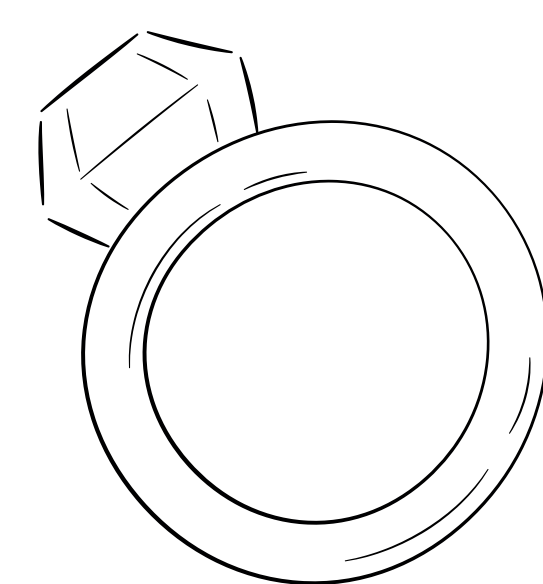
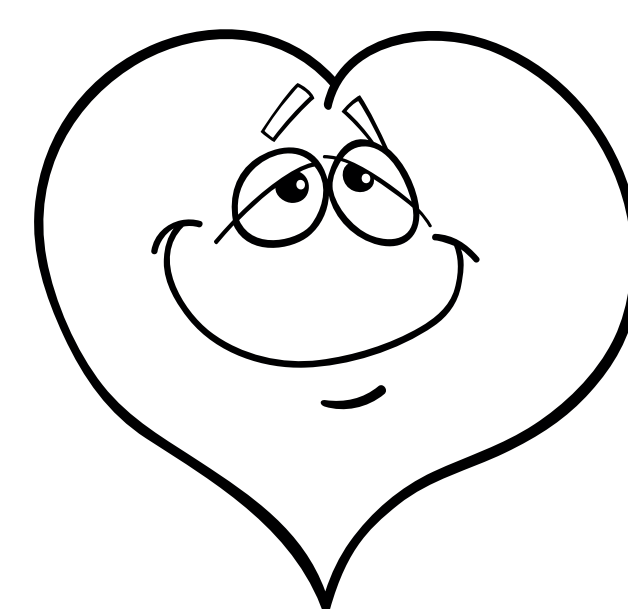
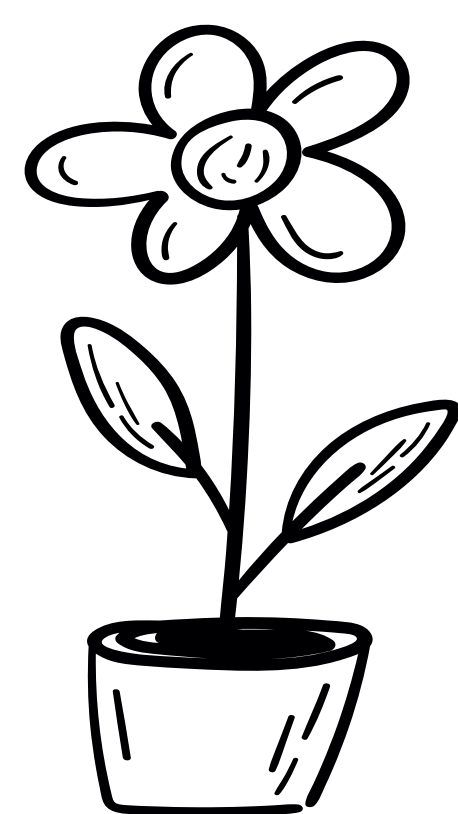
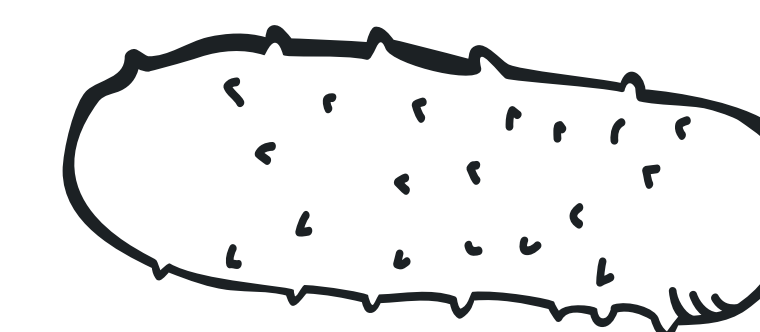
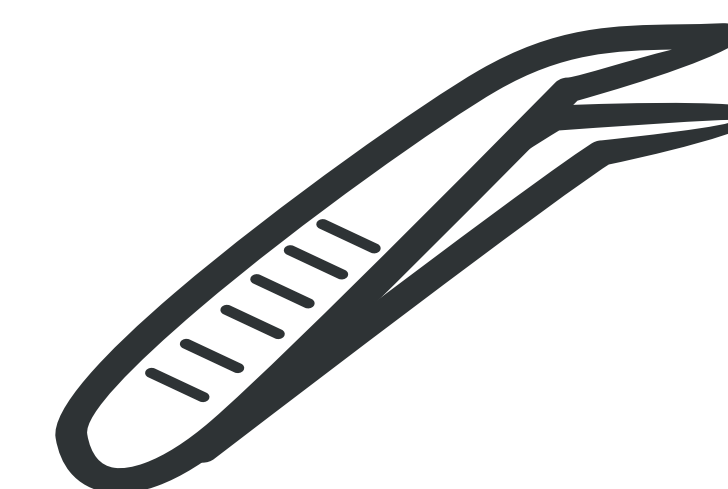
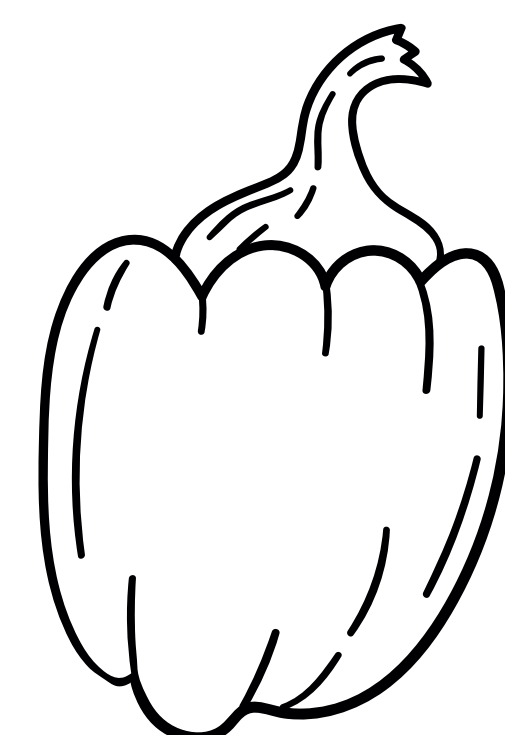
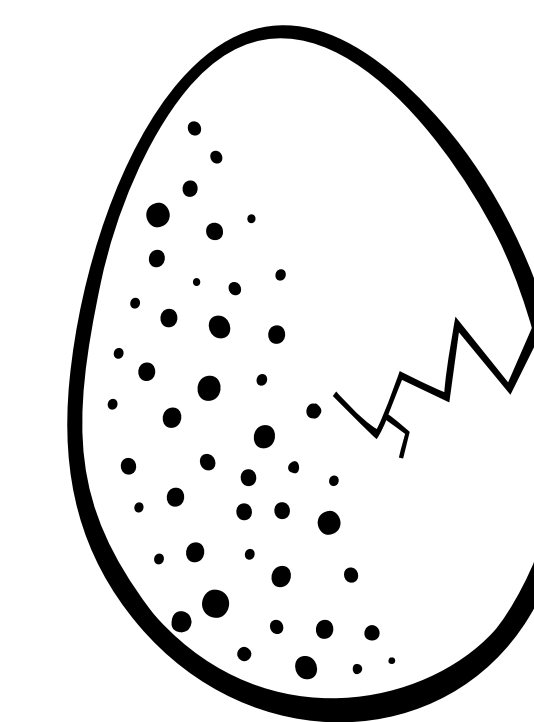
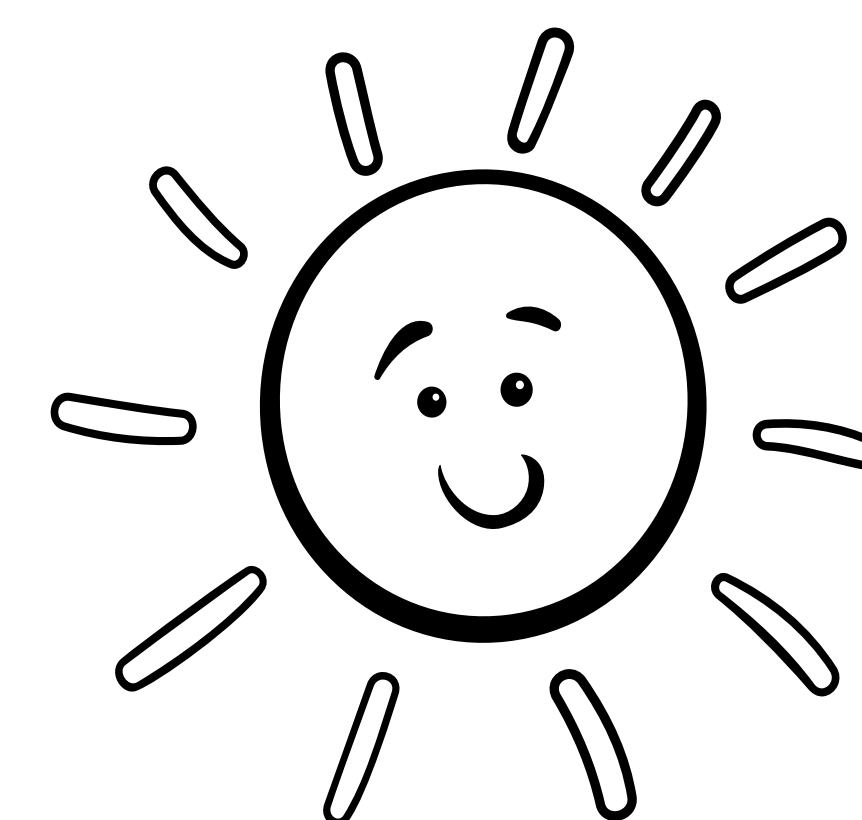
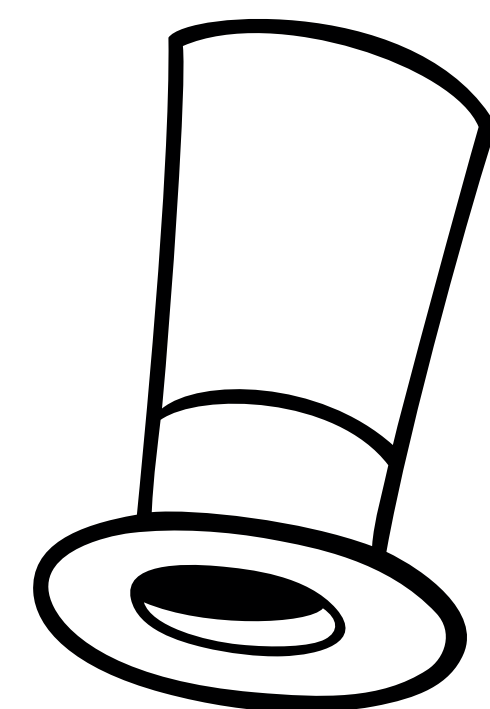
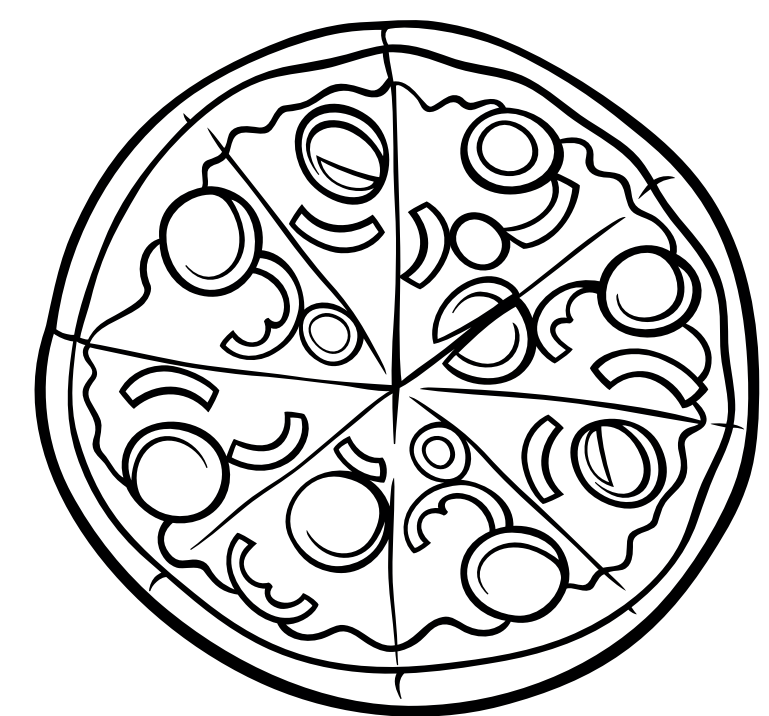

deti-i-mama.ru

vini.by



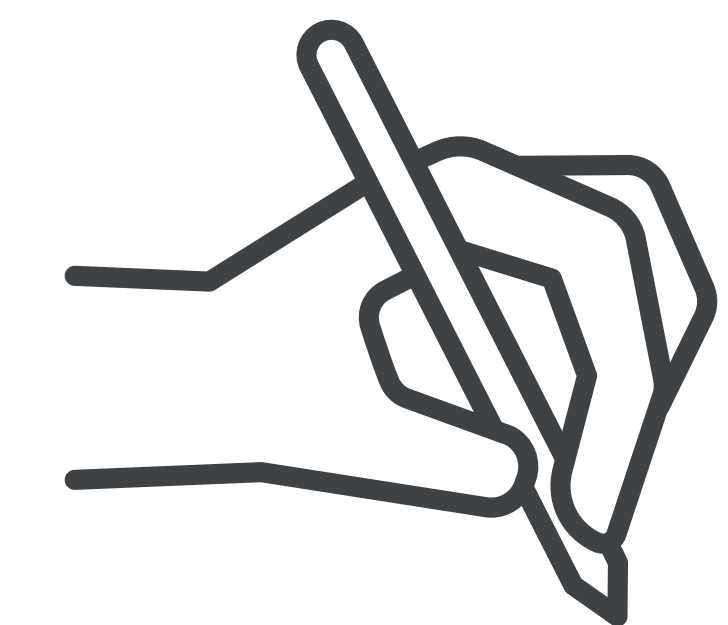

левая рука

Найди и назови одинаковые картинке слева и справа. Обведи их двумя руками одновременно

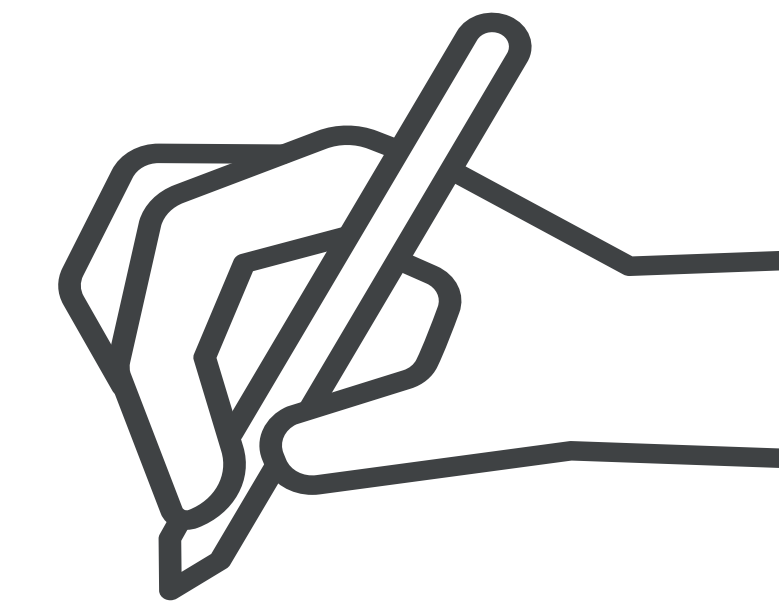

правая рука



deti-i-mama.ru



vini.by



Щ

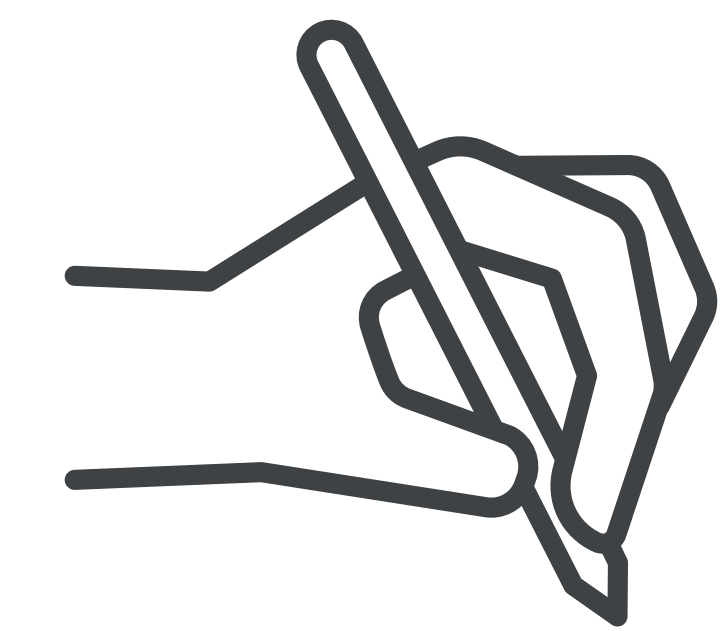

левая рука

Найди и назови одинаковые картинке слева и справа. Обведи их двумя руками одновременно

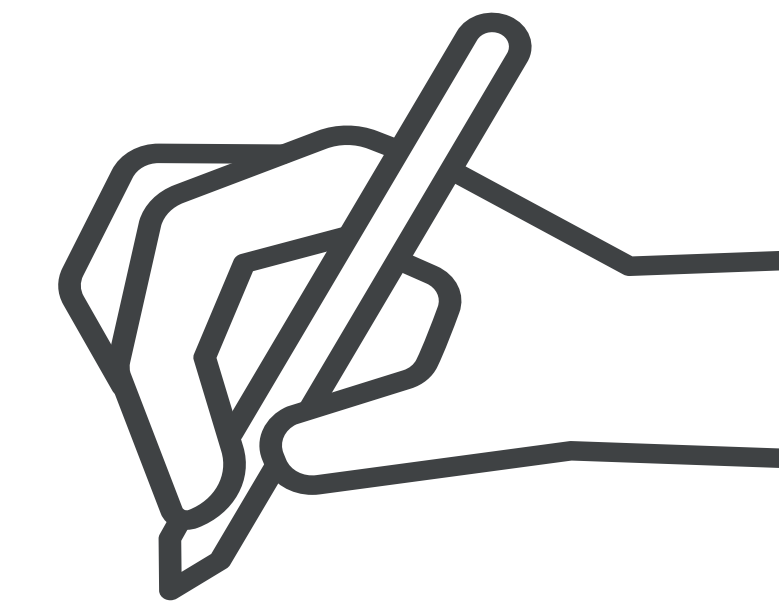

правая рука

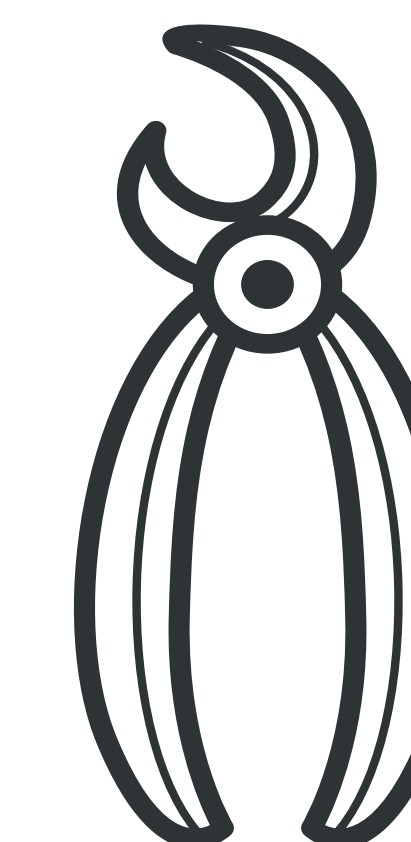
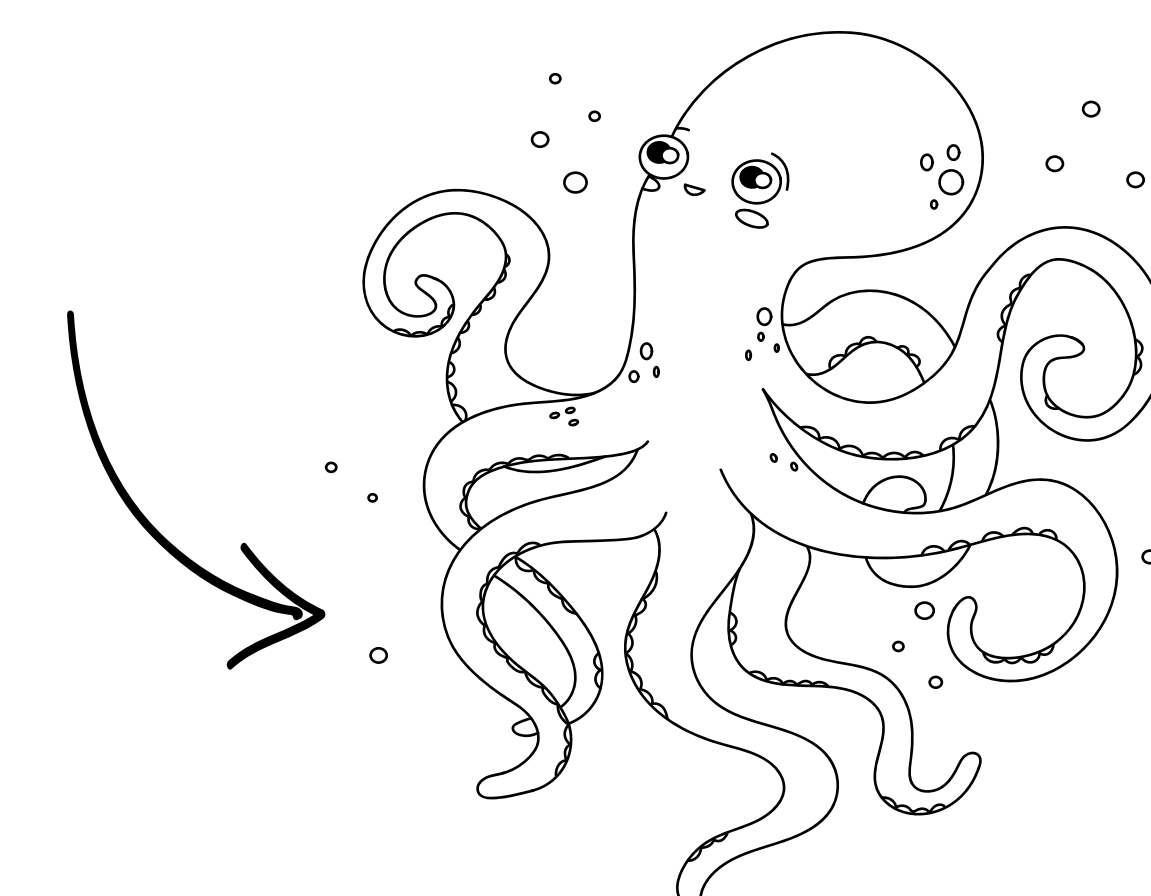
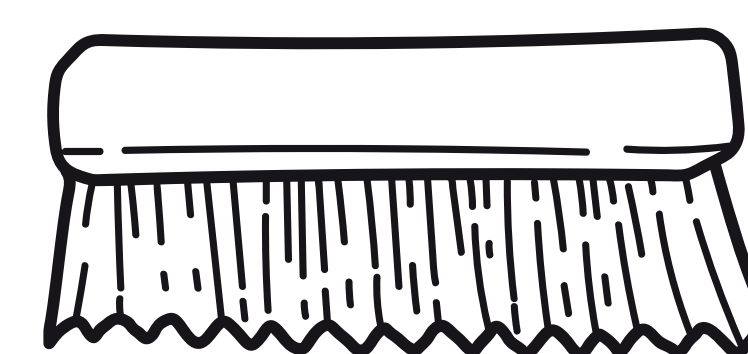
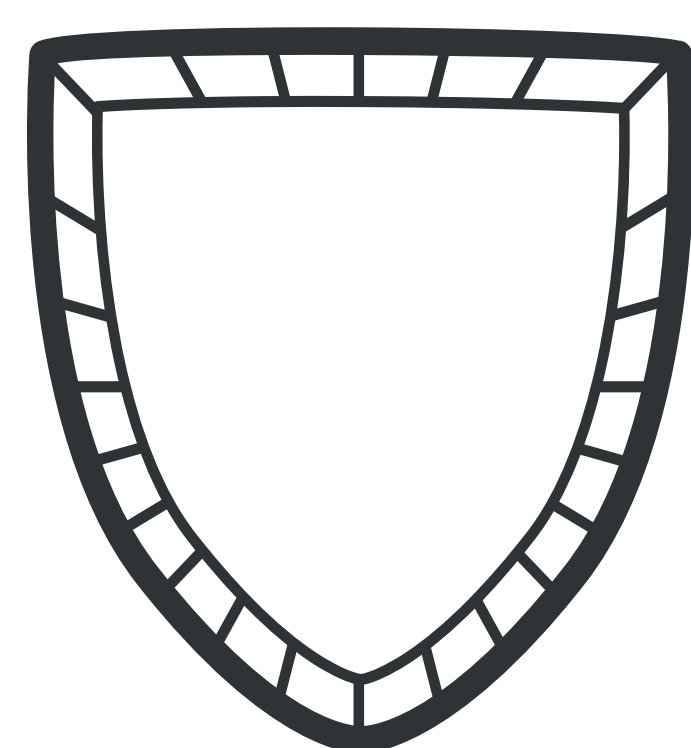
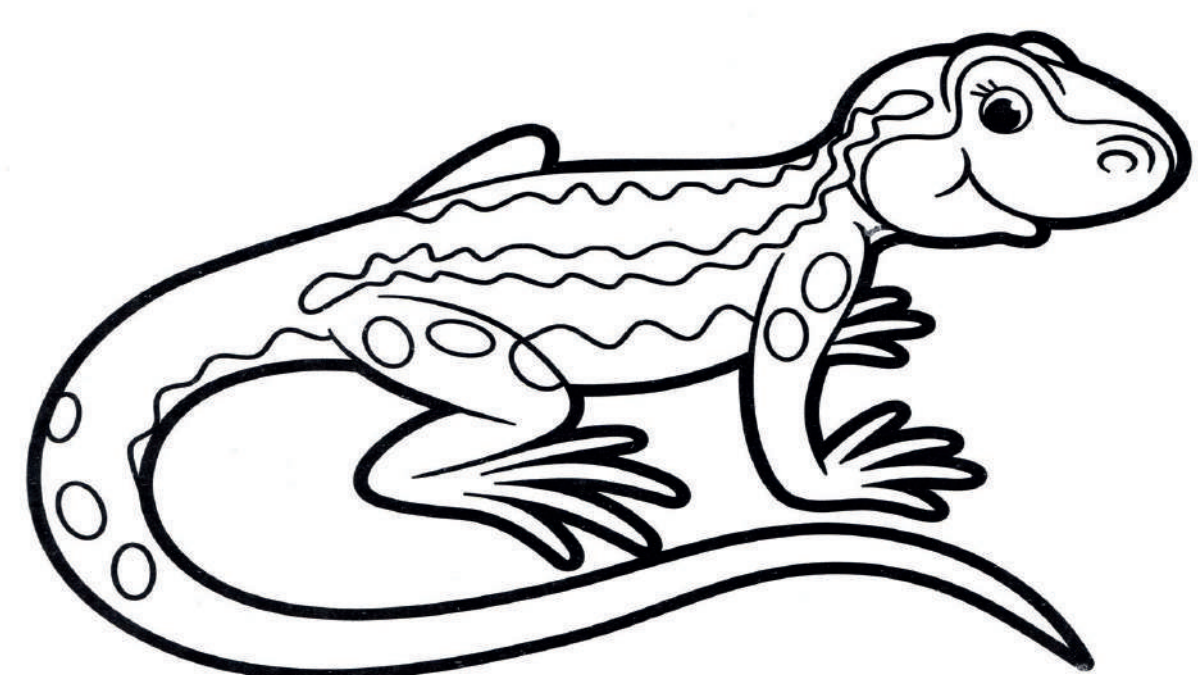
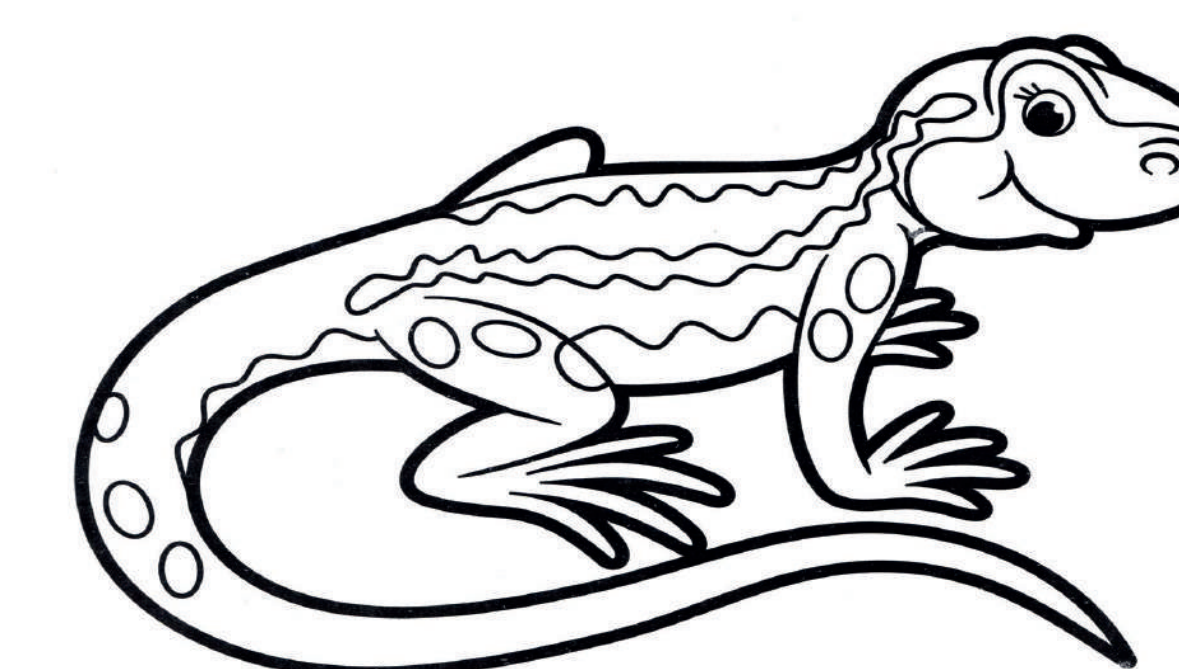
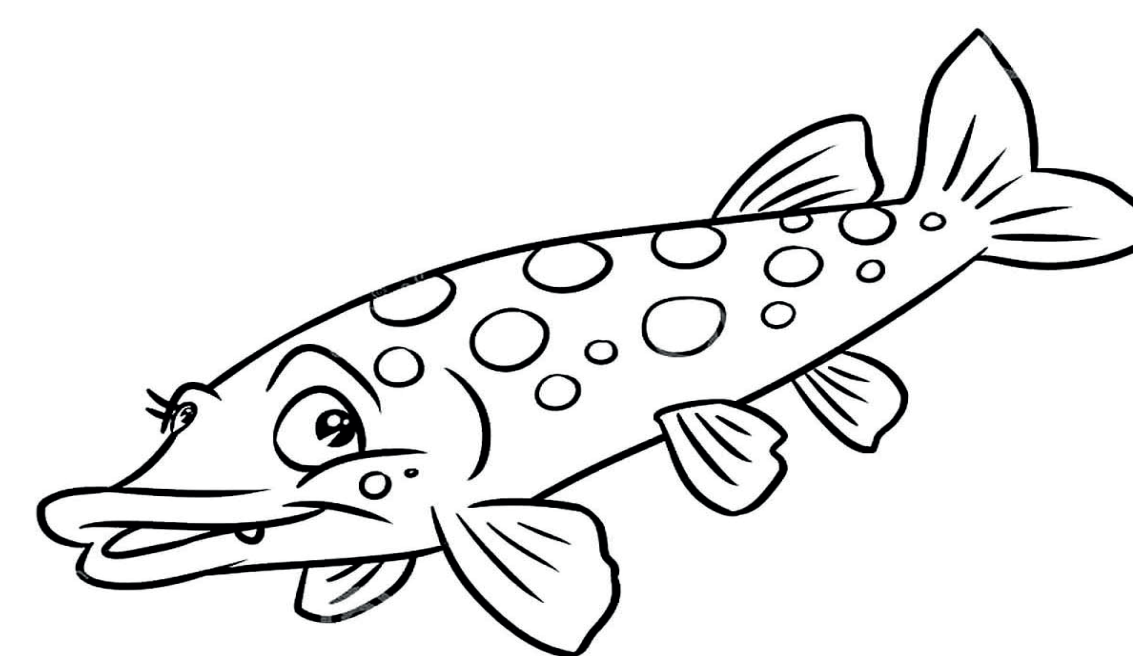
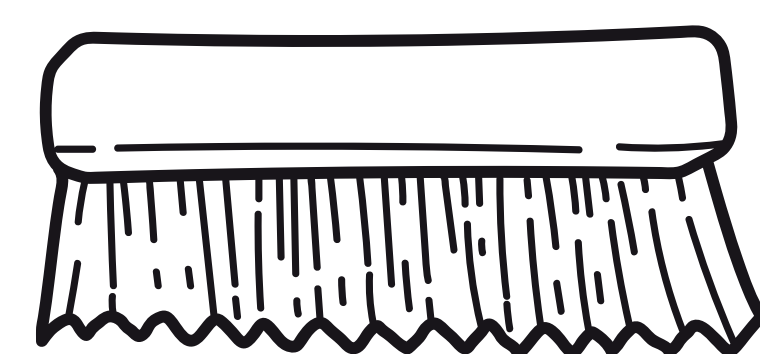
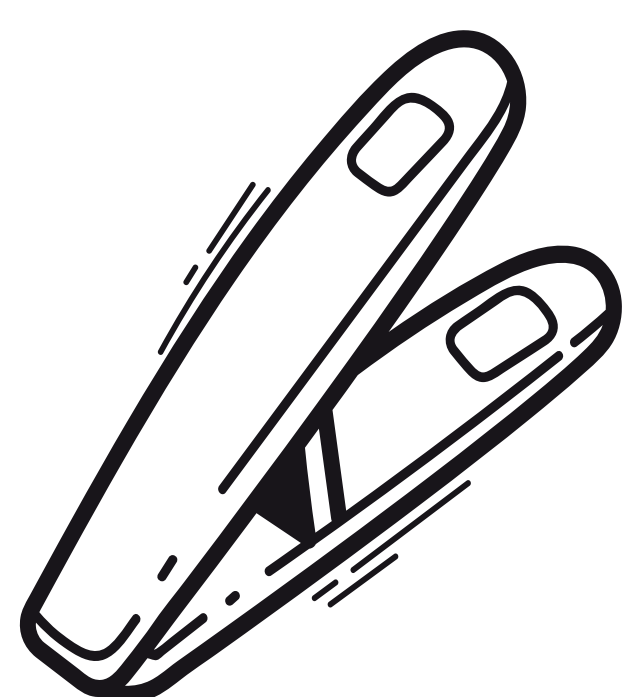
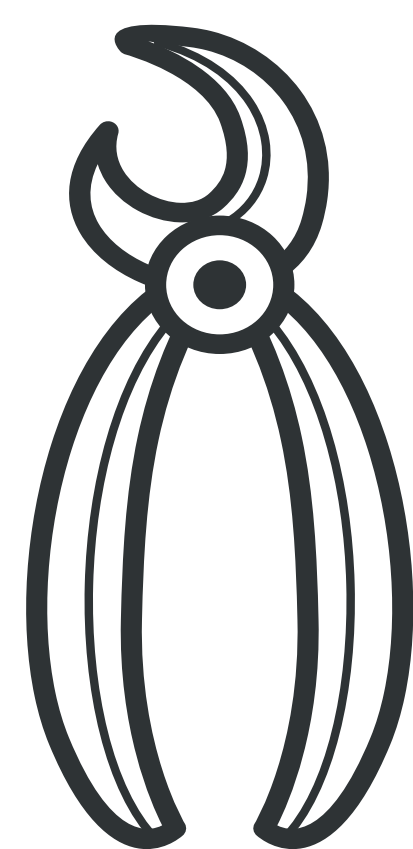
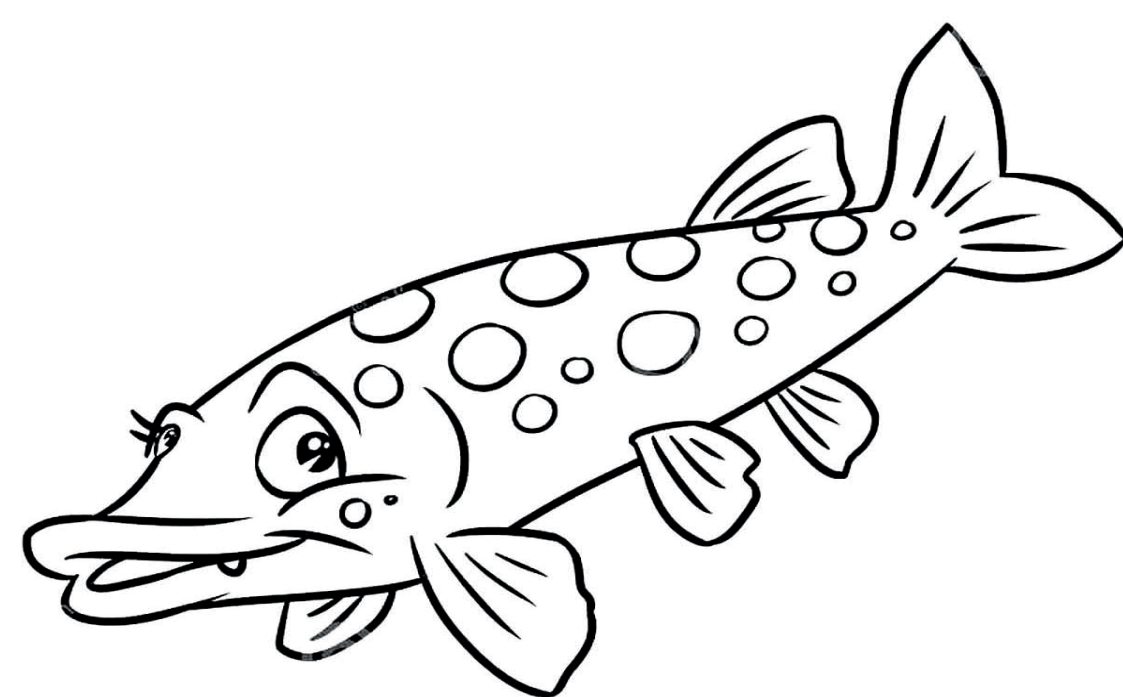
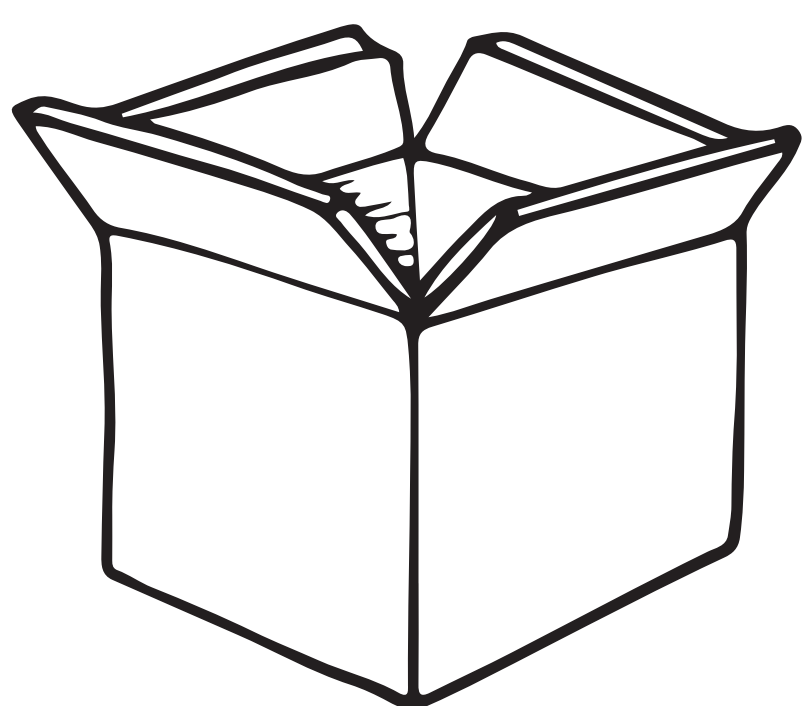
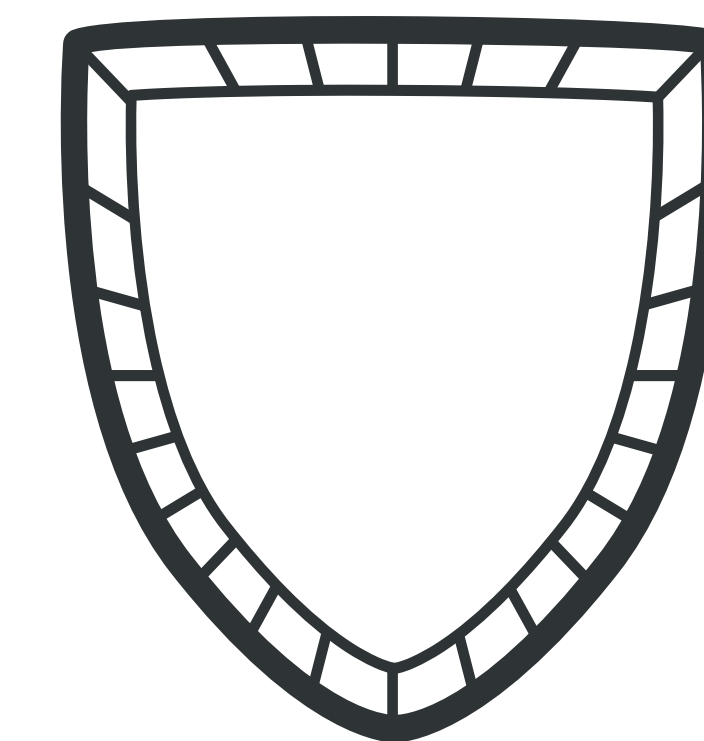
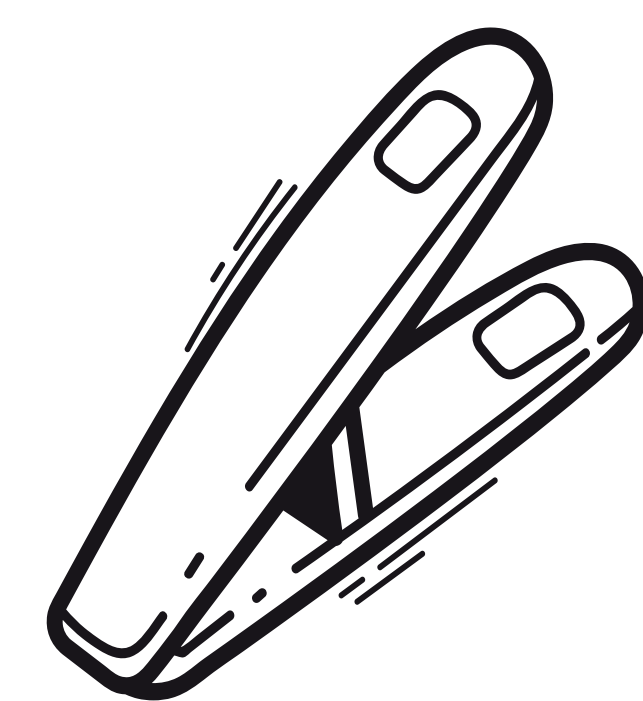
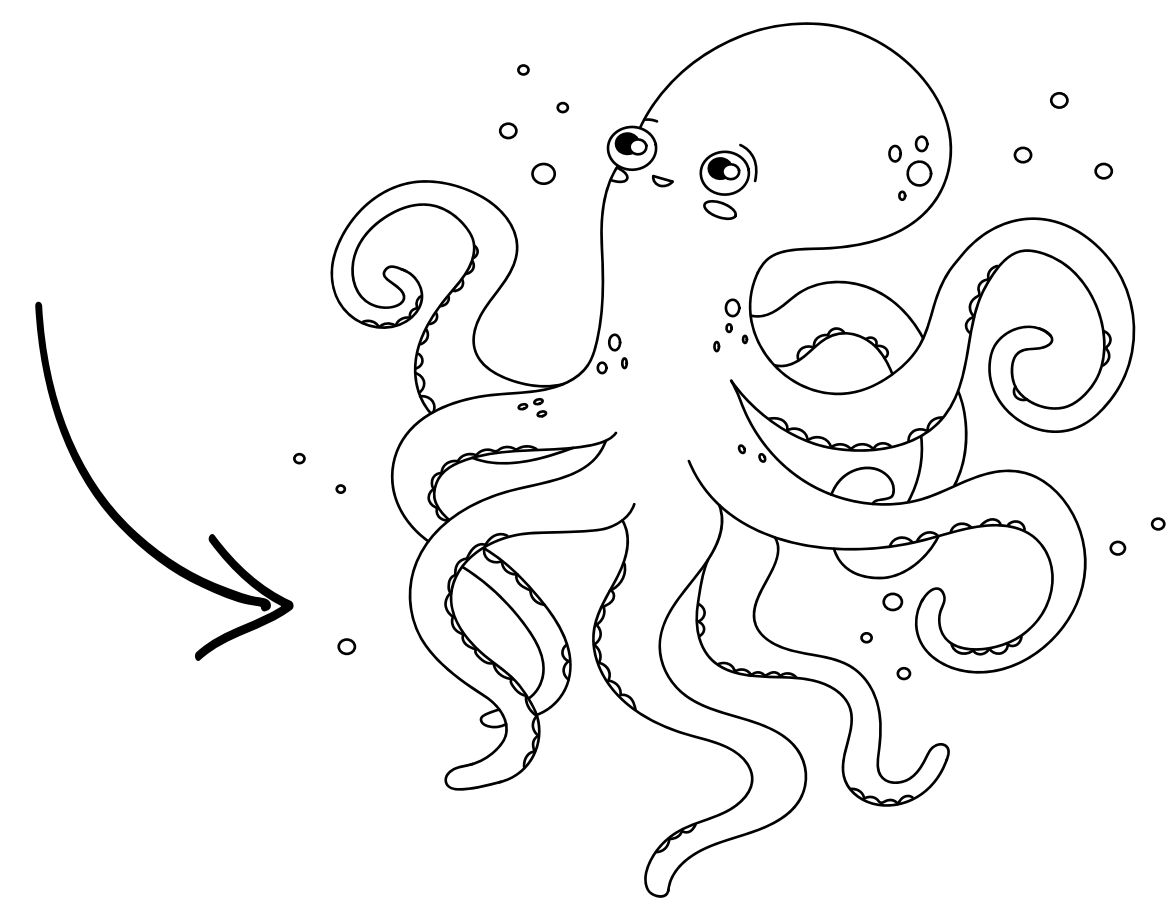

deti-i-mama.ru

vini.by



Ш

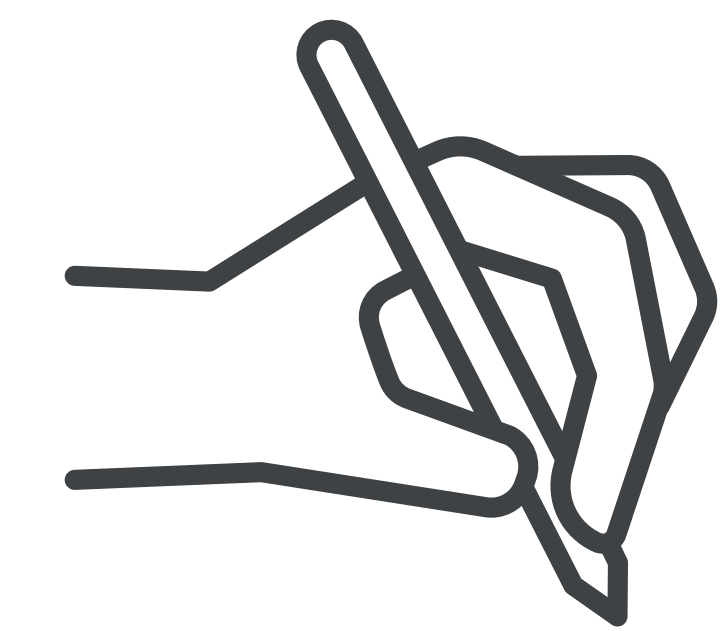

левая рука

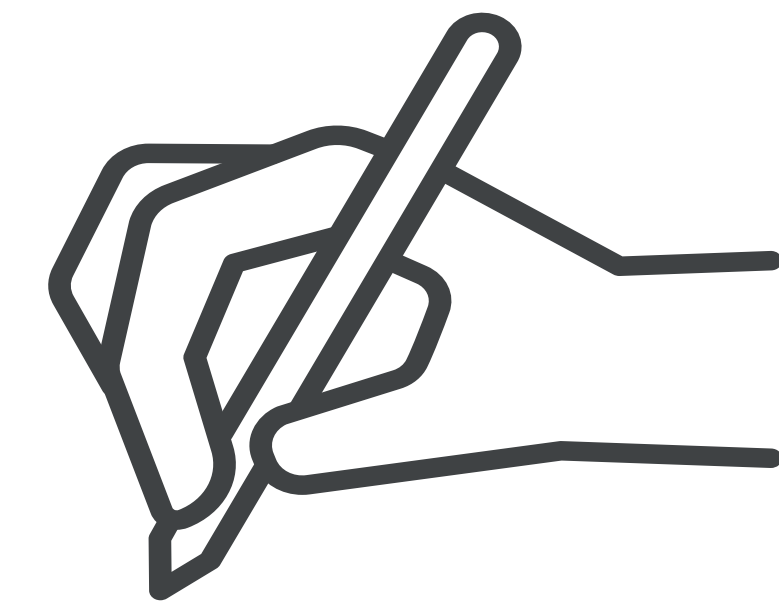

правая рука

Найди и назови одинаковые картинки слева и справа. Обведи их двумя руками одновременно

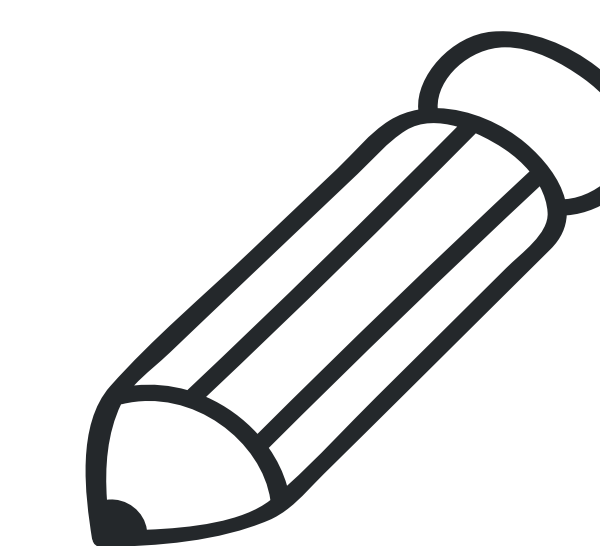
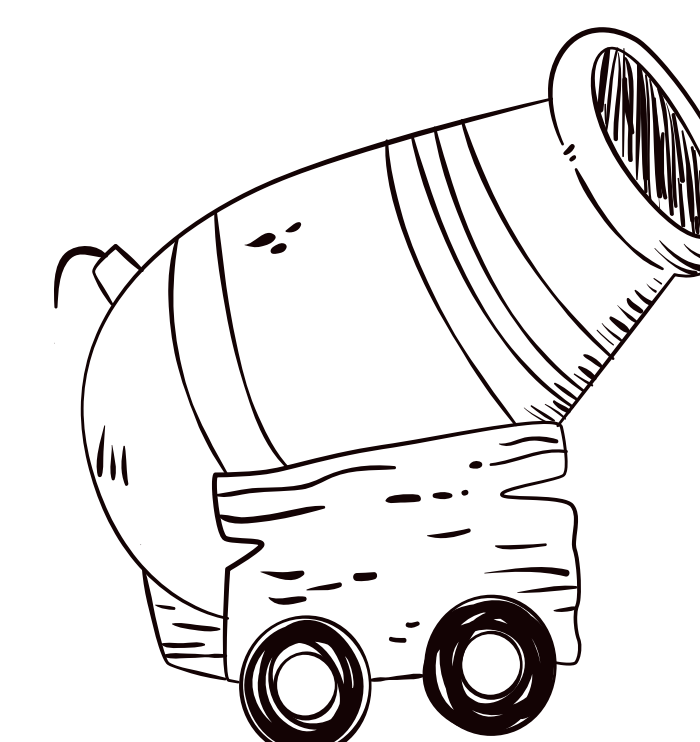
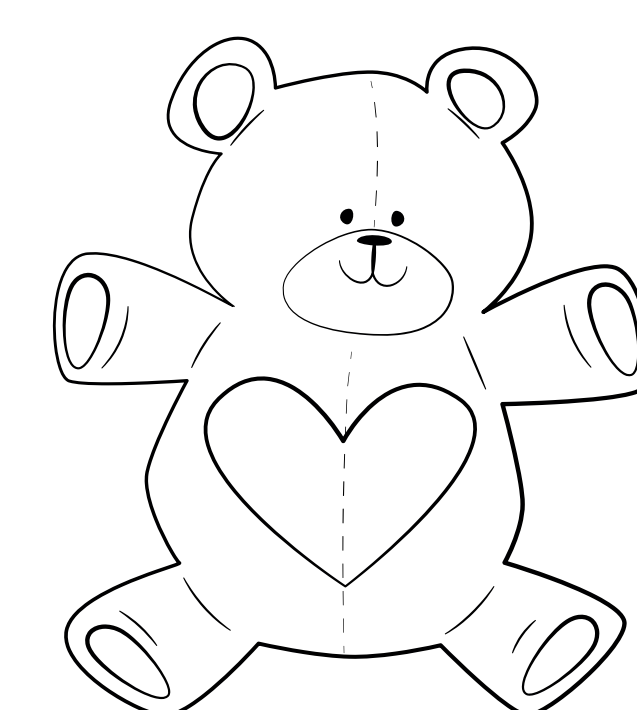
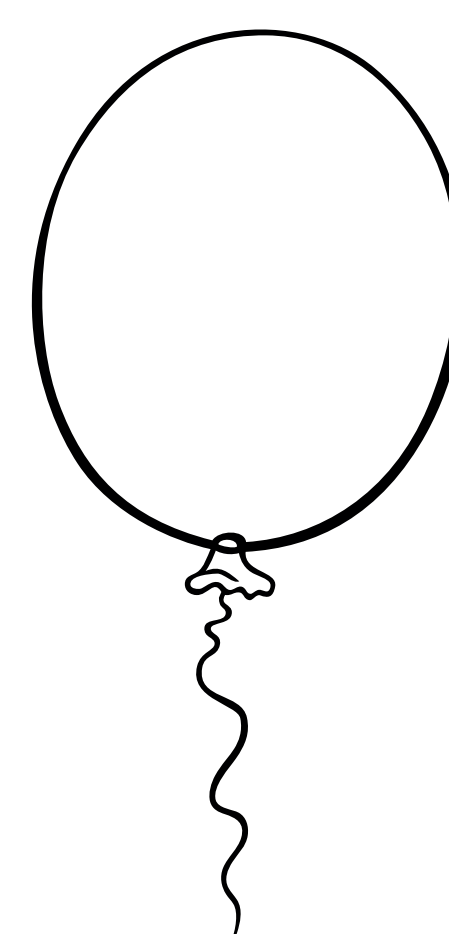
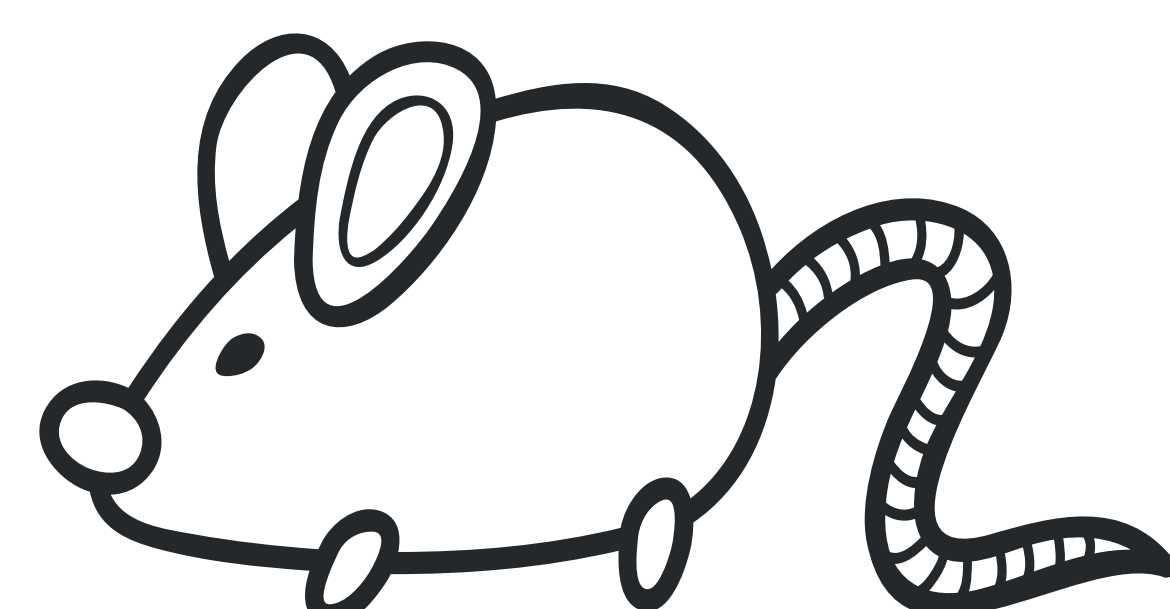
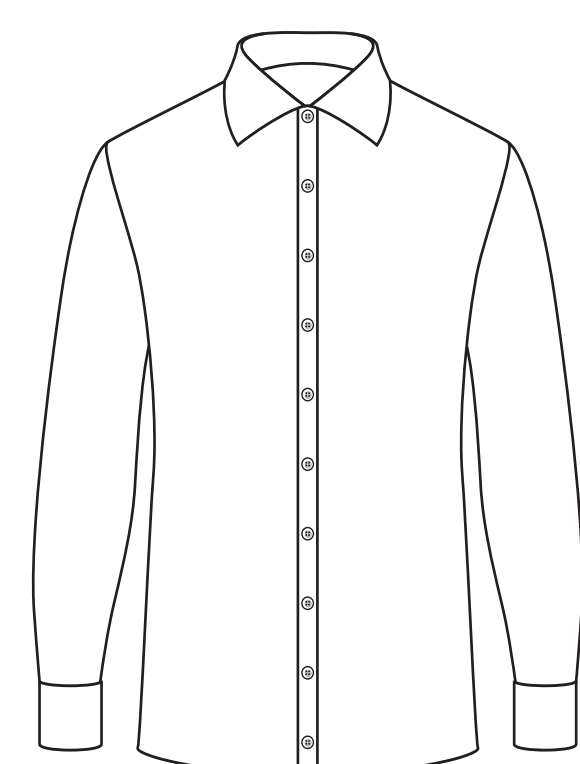
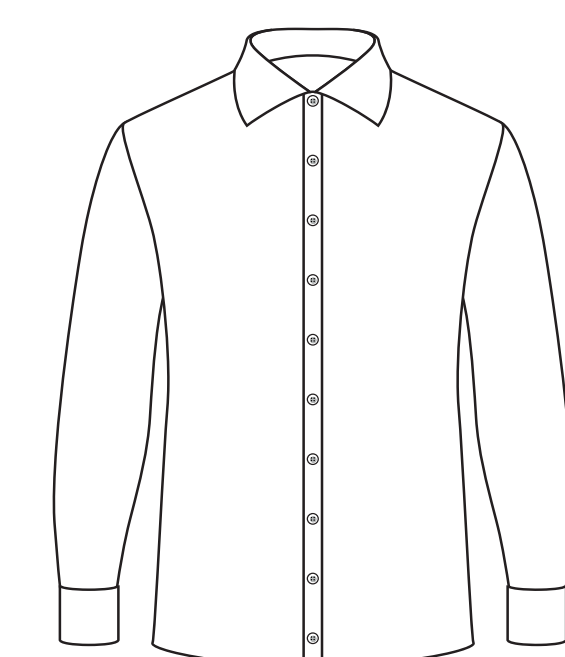
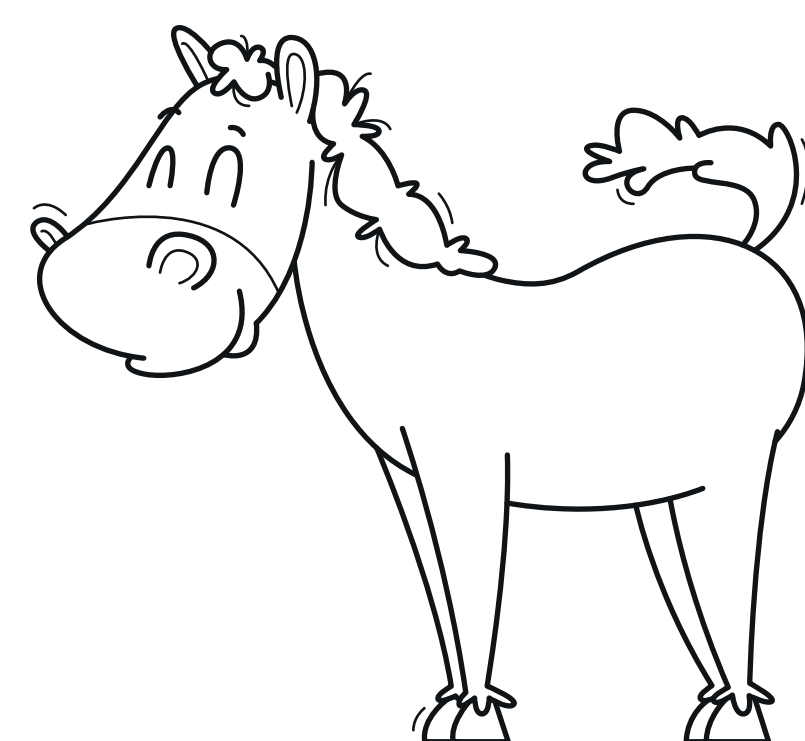
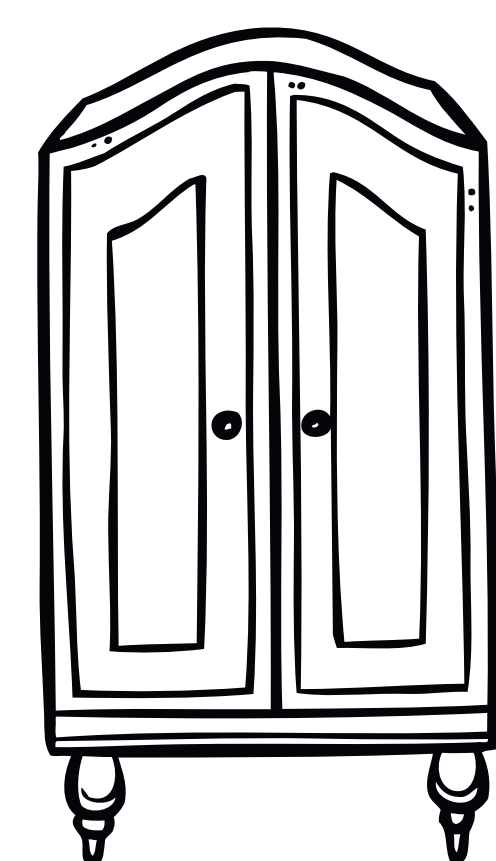
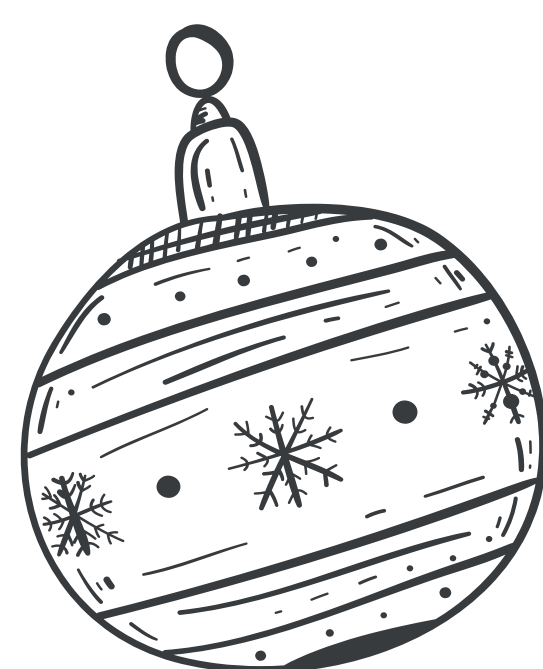
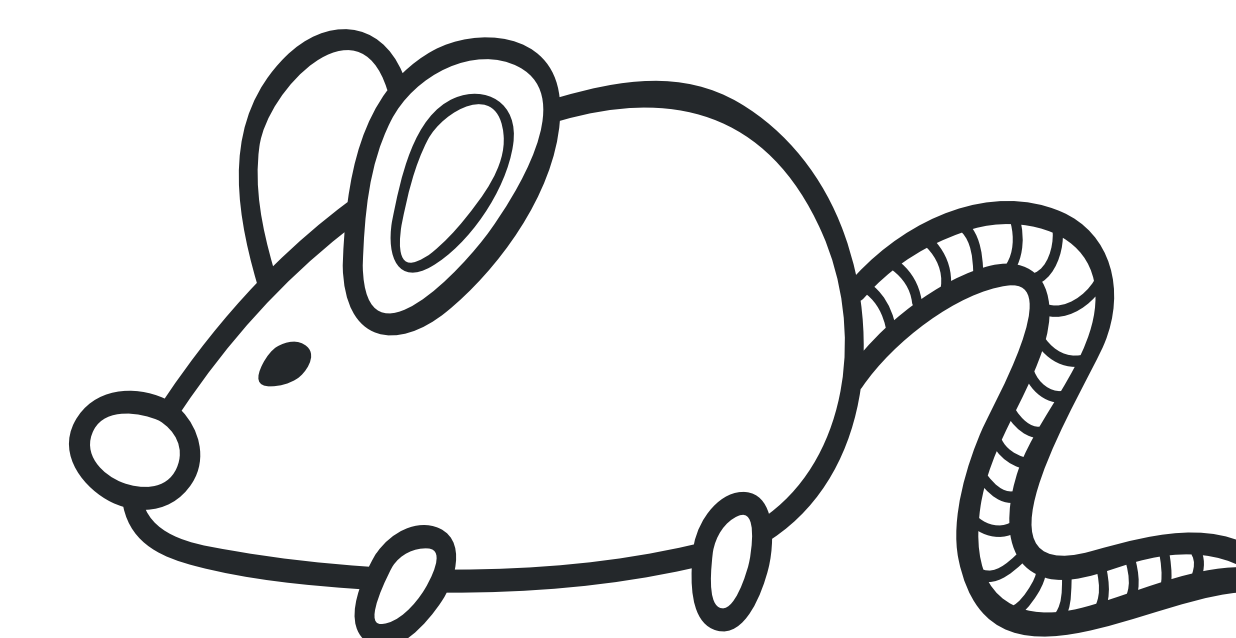
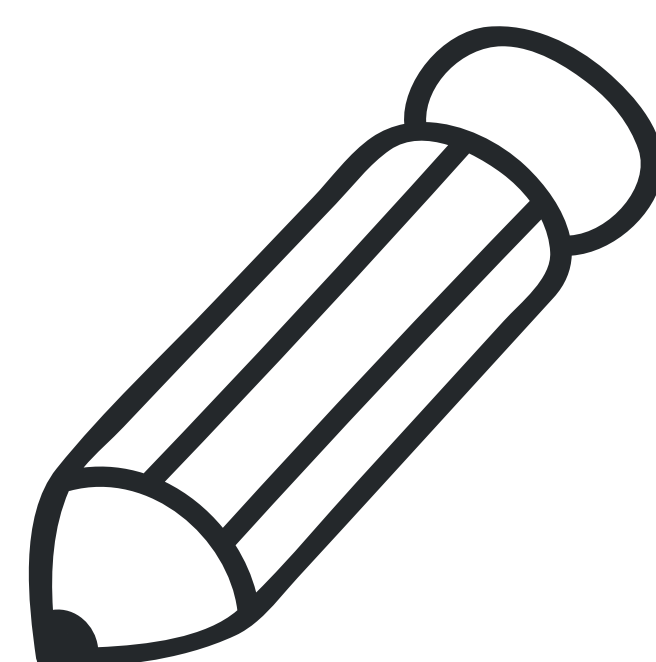
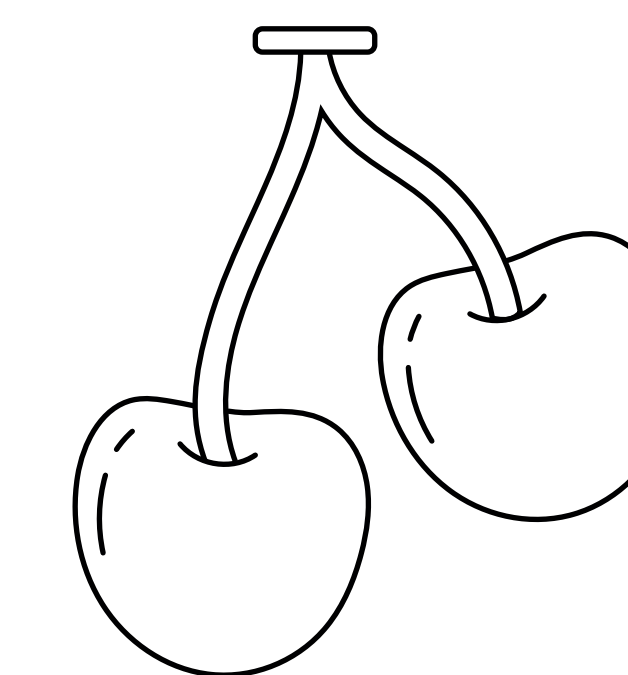
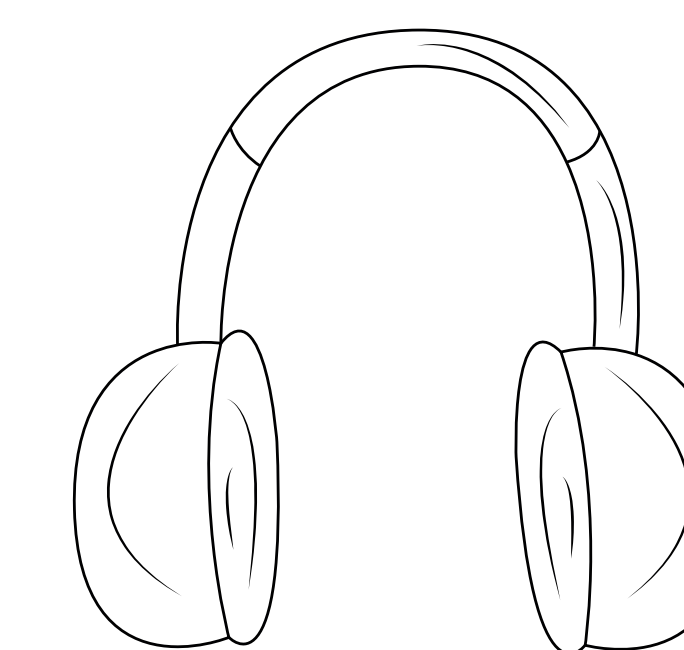
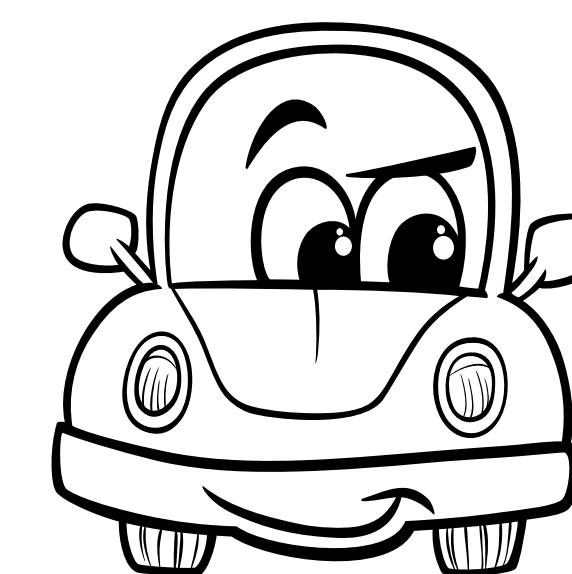
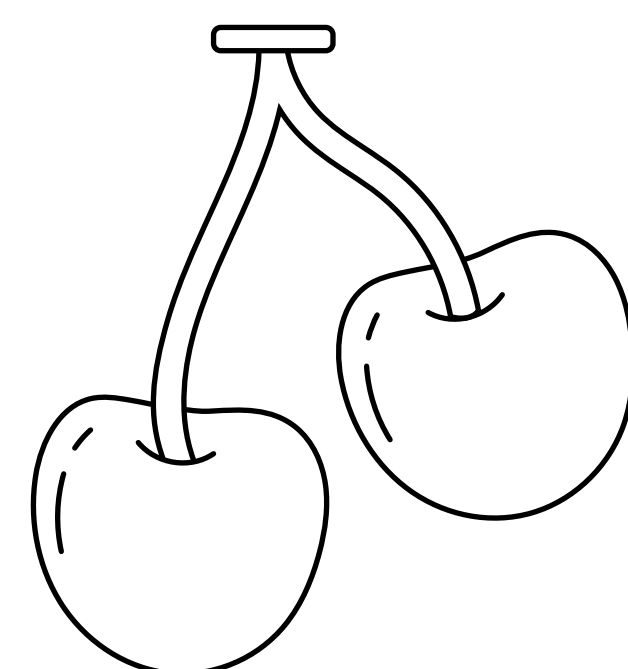
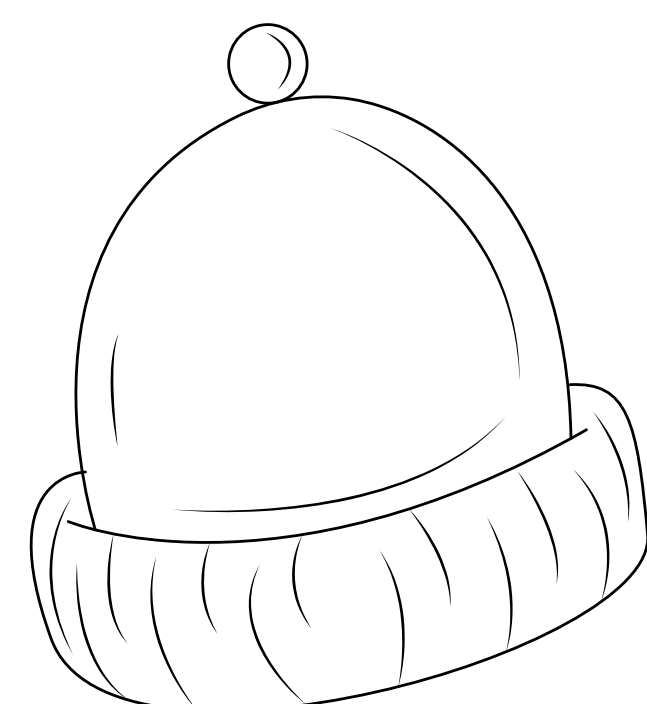
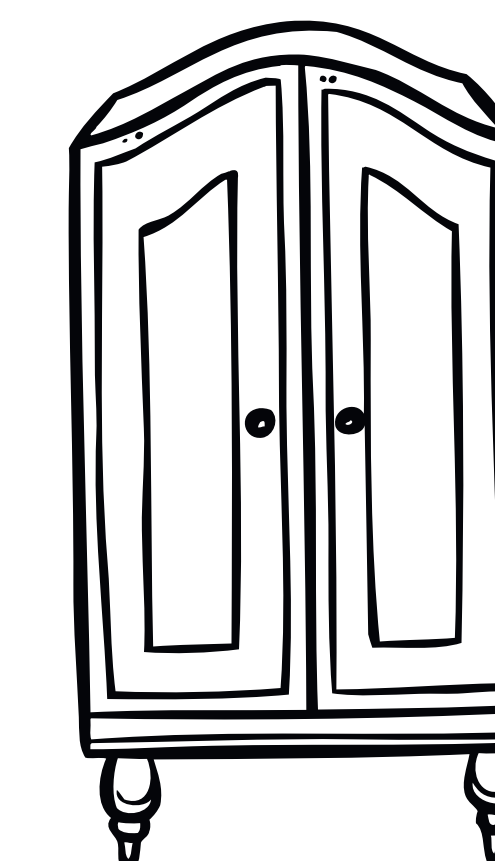
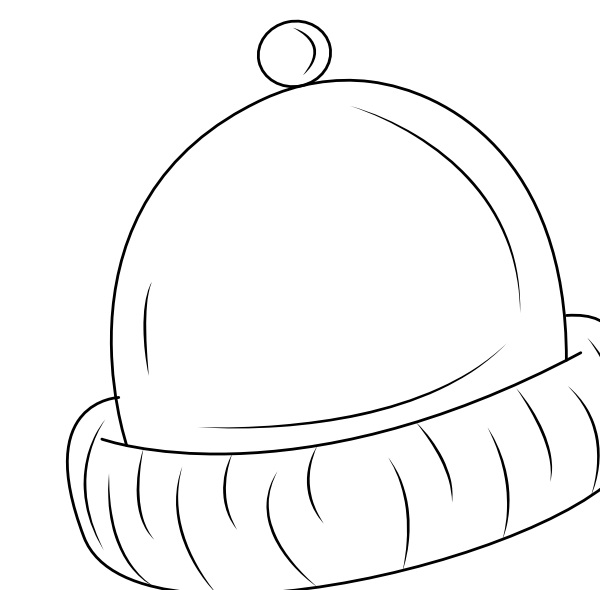
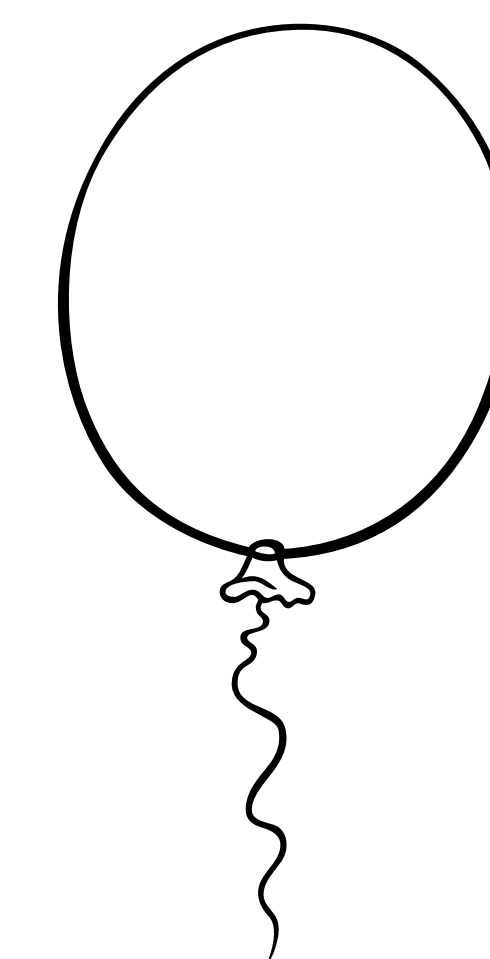
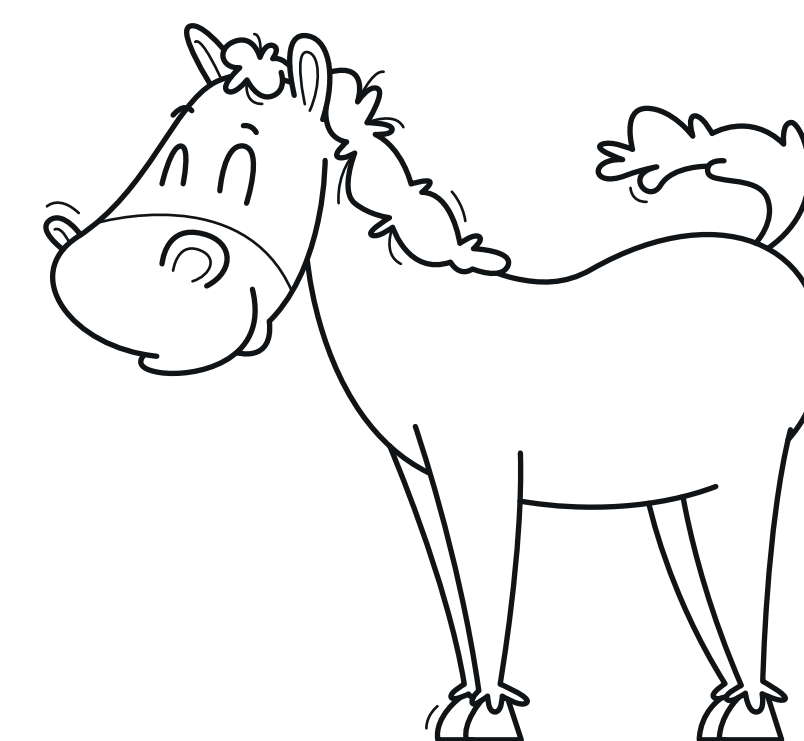
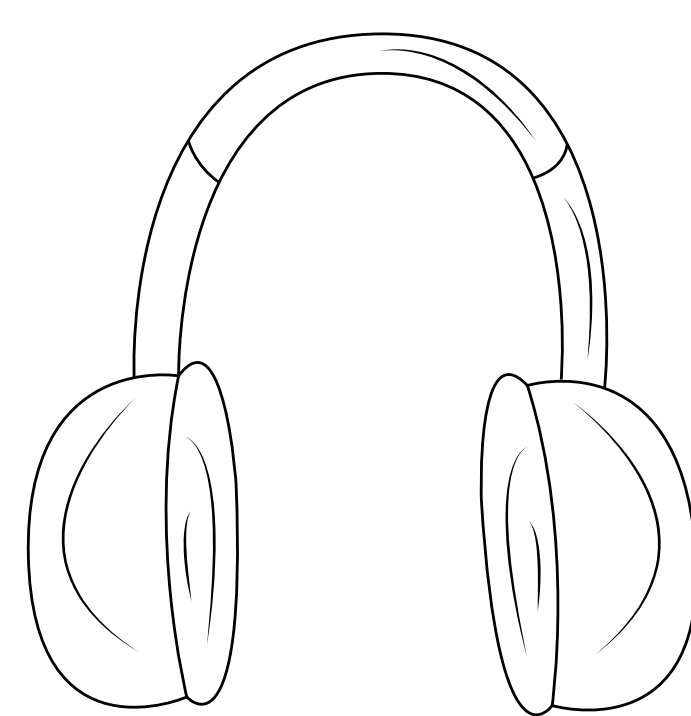
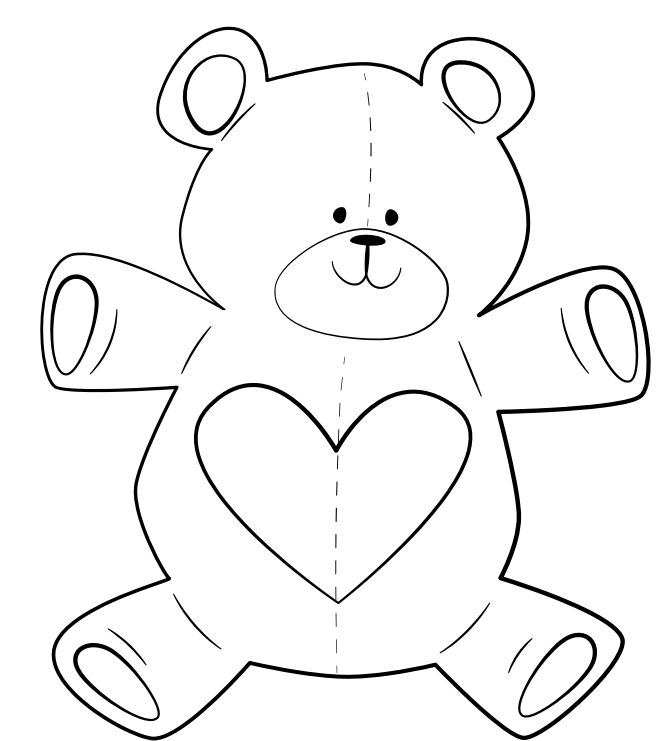

deti-i-mama.ru

vini.by



Ж

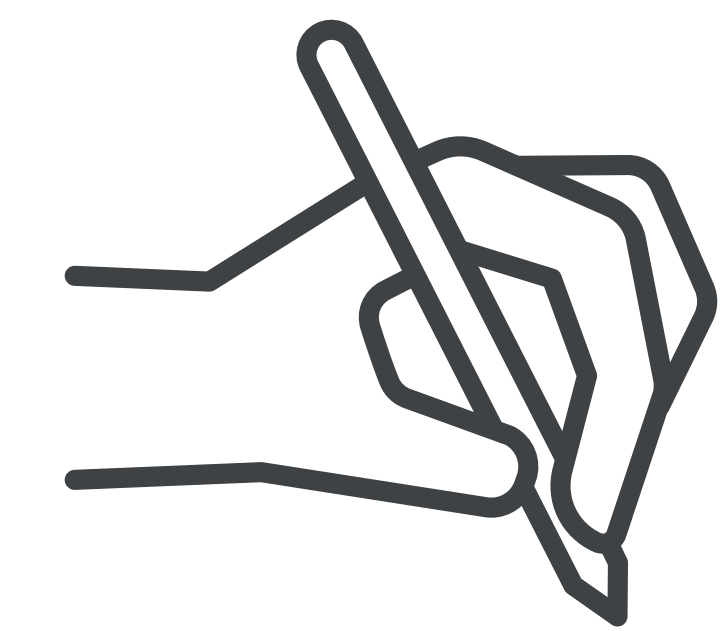

левая рука

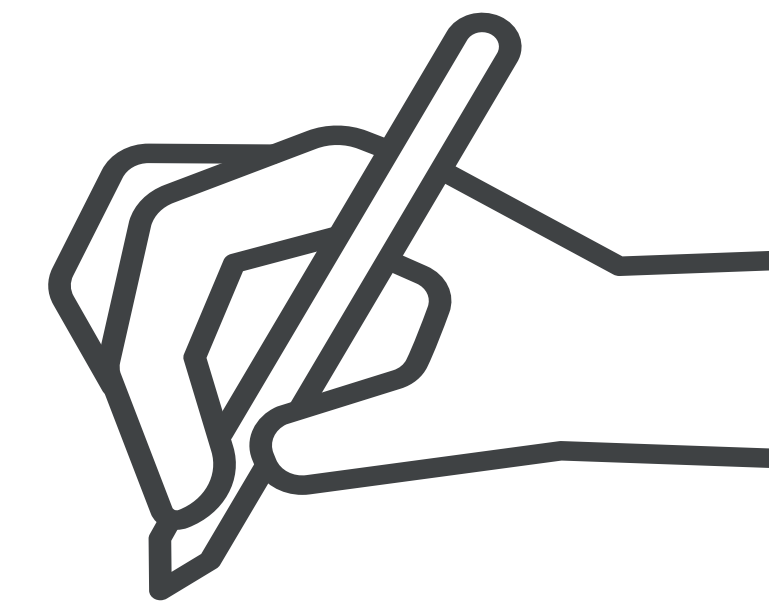

правая рука

Найди и назови одинаковые картинки слева и справа. Обведи их двумя руками одновременно

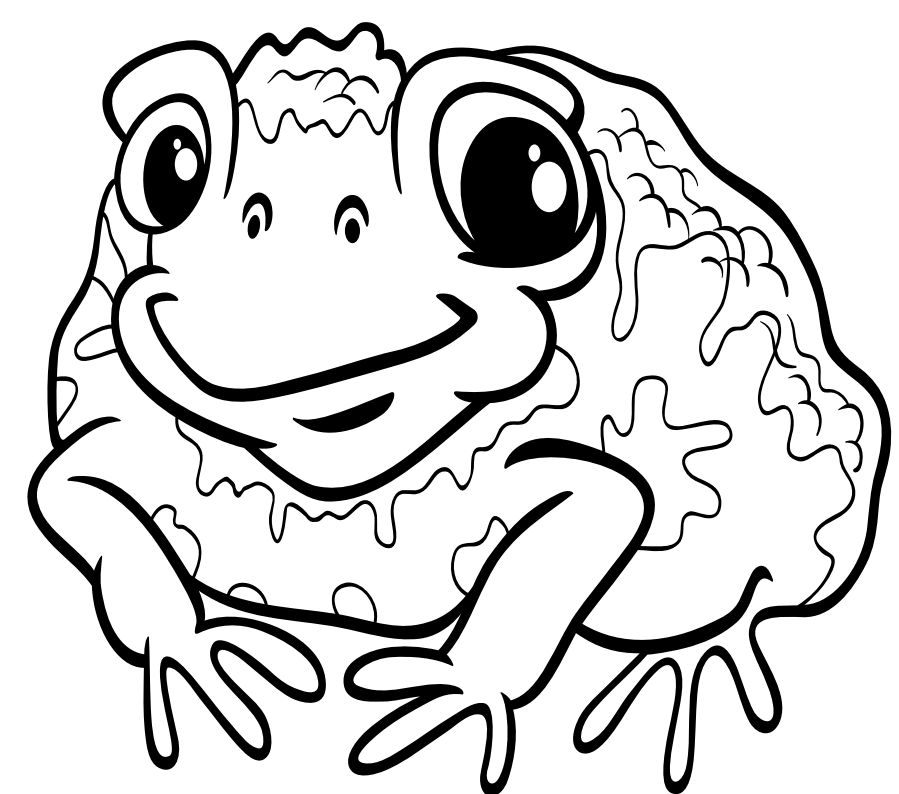
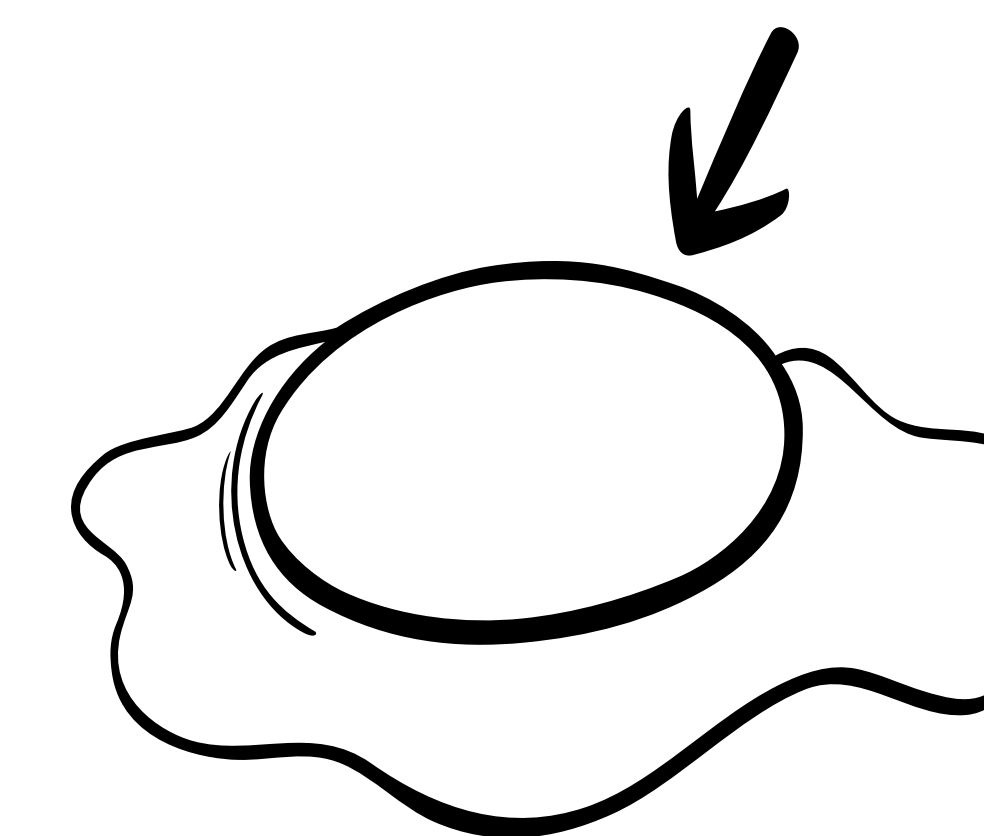
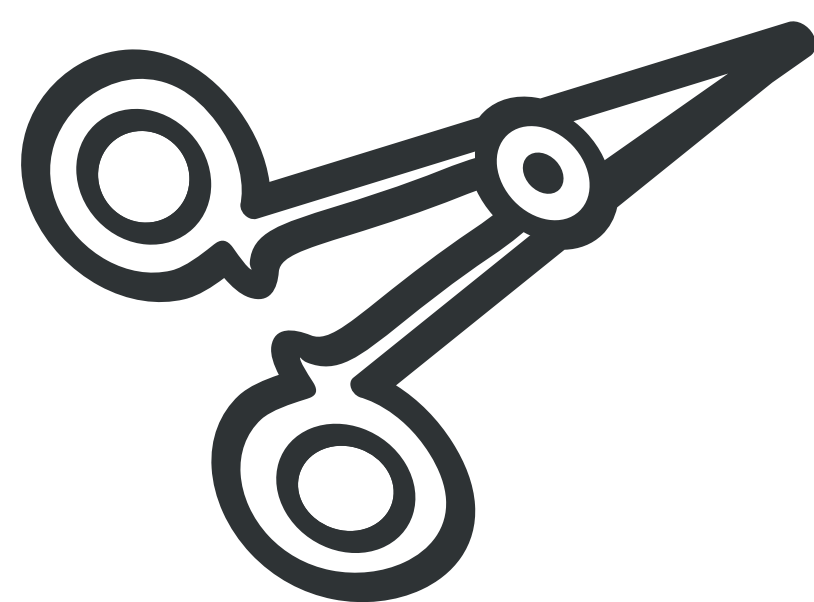
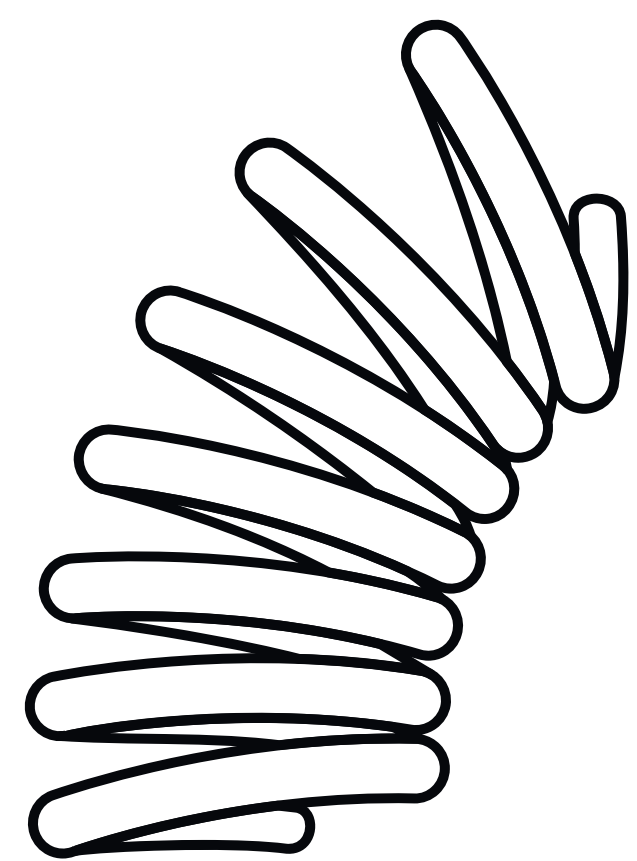
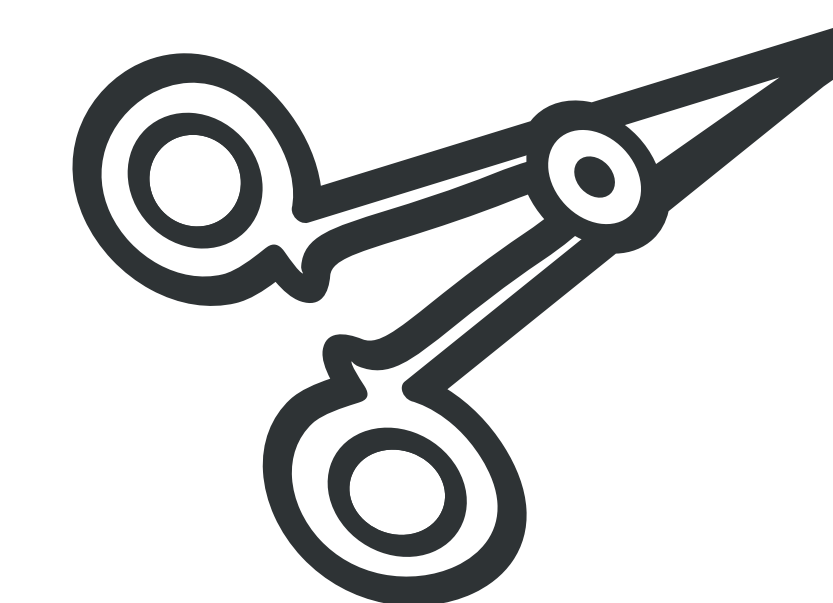
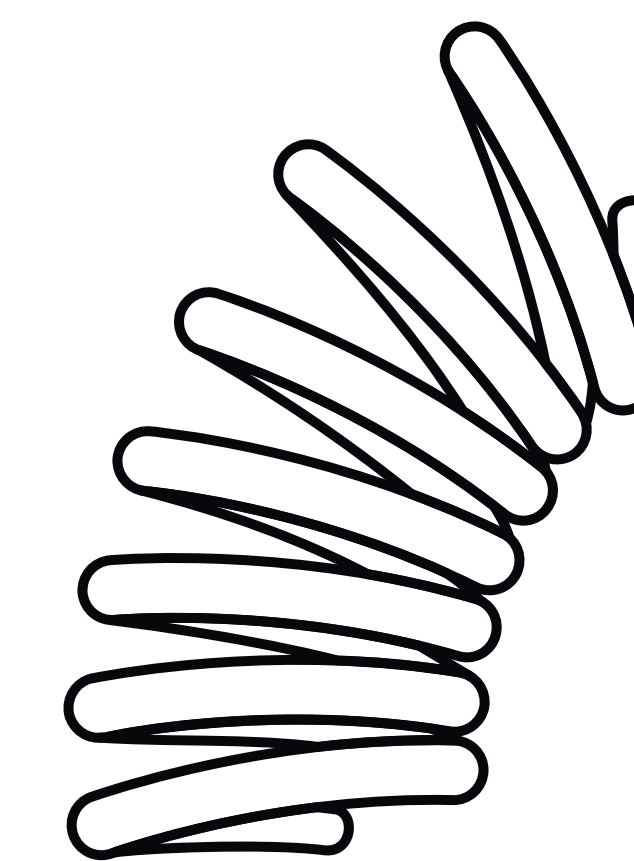
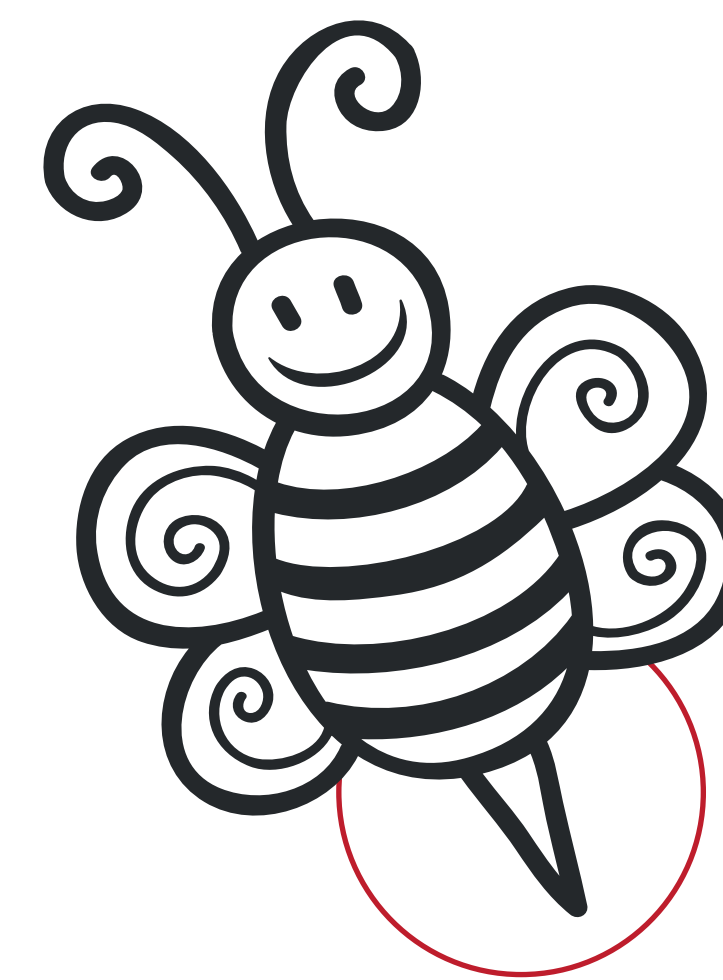
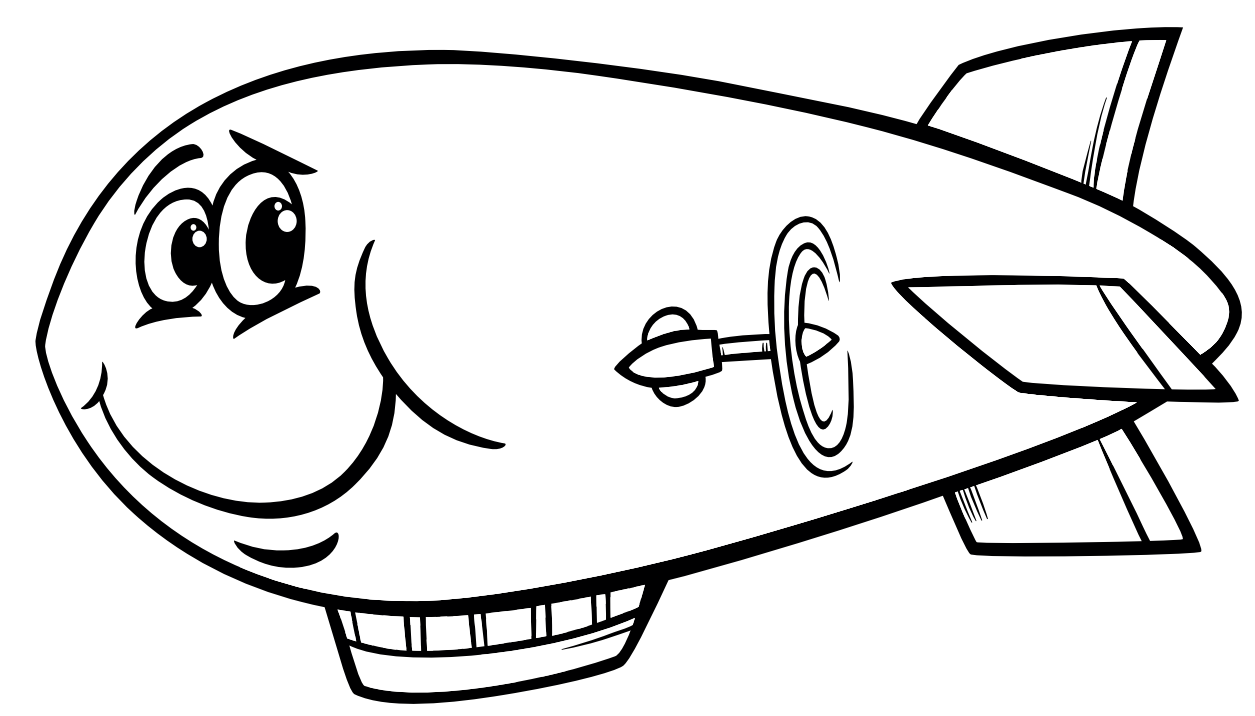
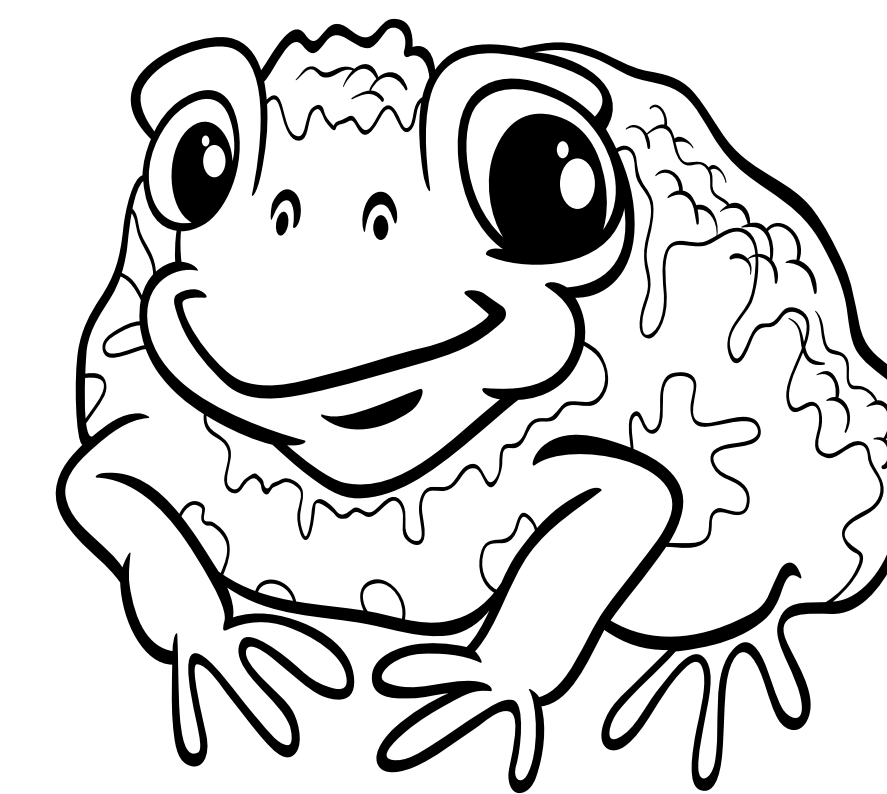
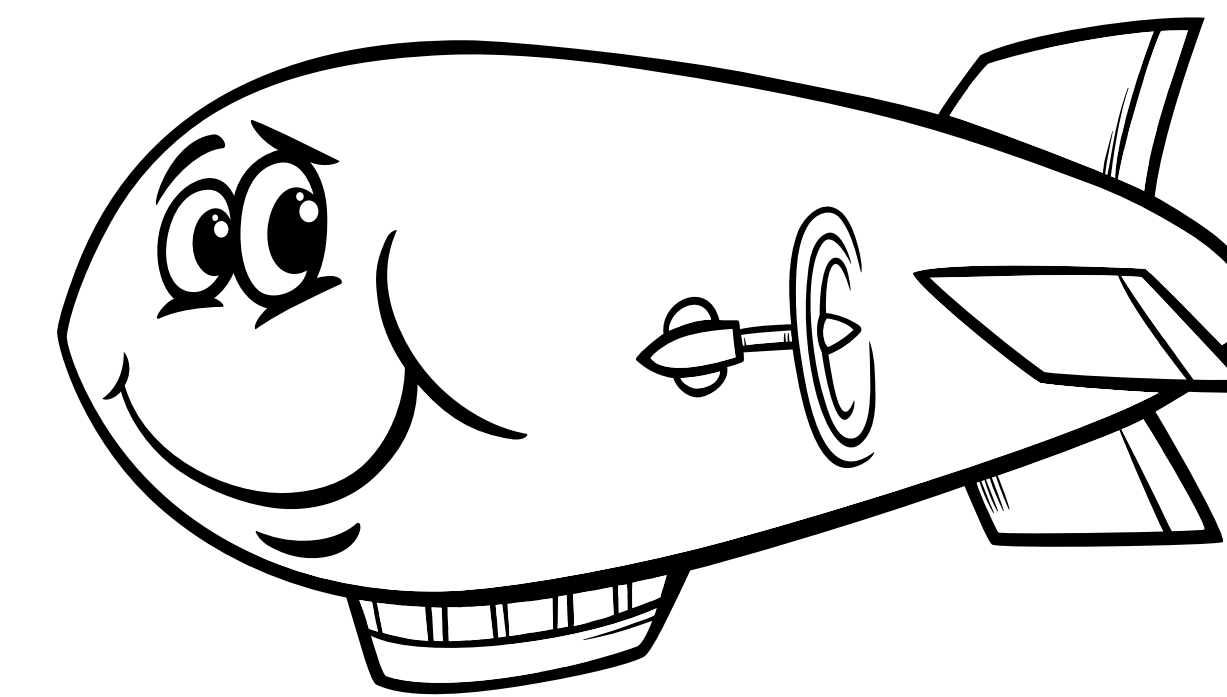
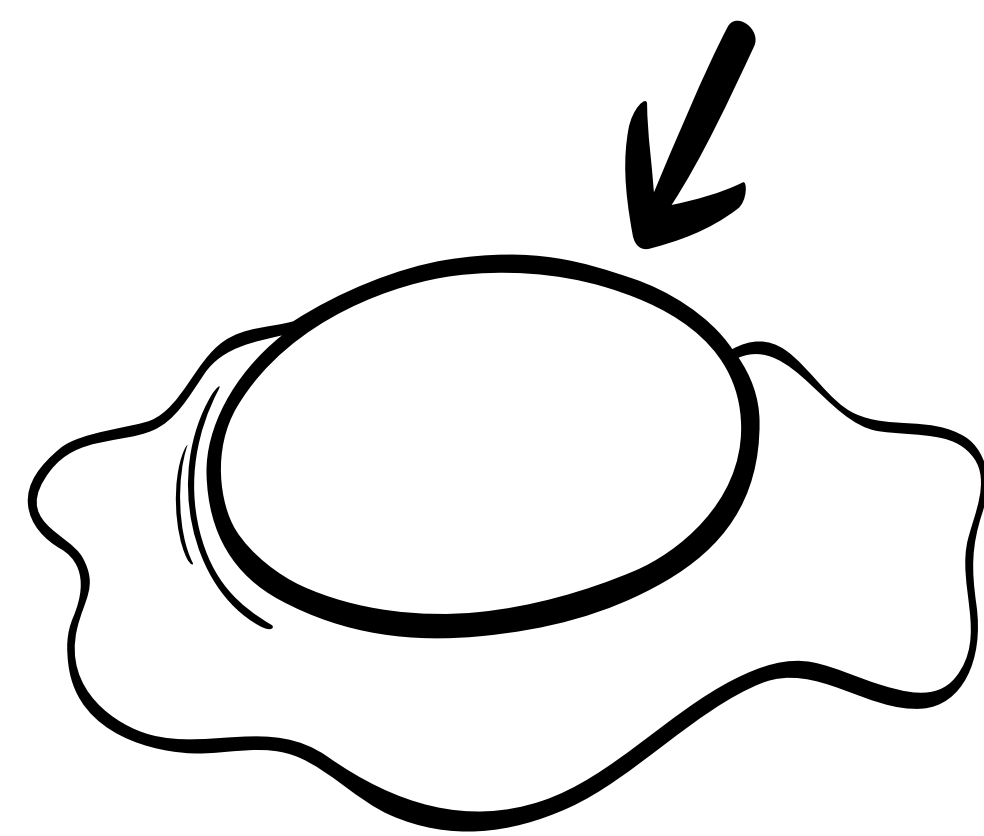
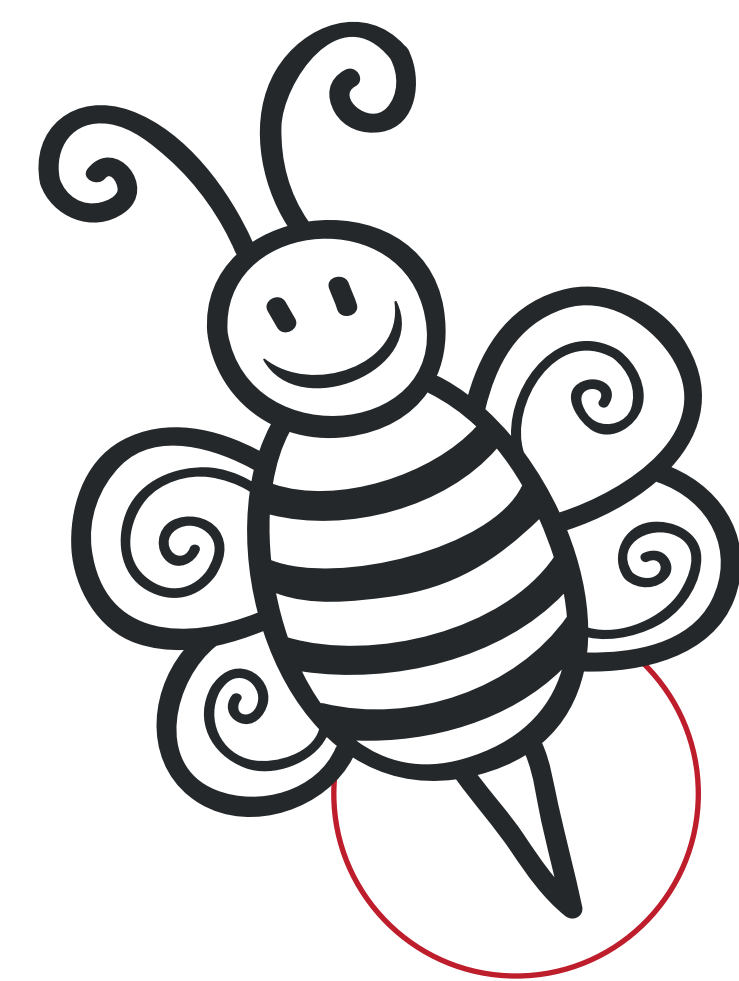



Л

Найди и назови одинаковые картинки слева и справа. Обведи их двумя руками одновременно

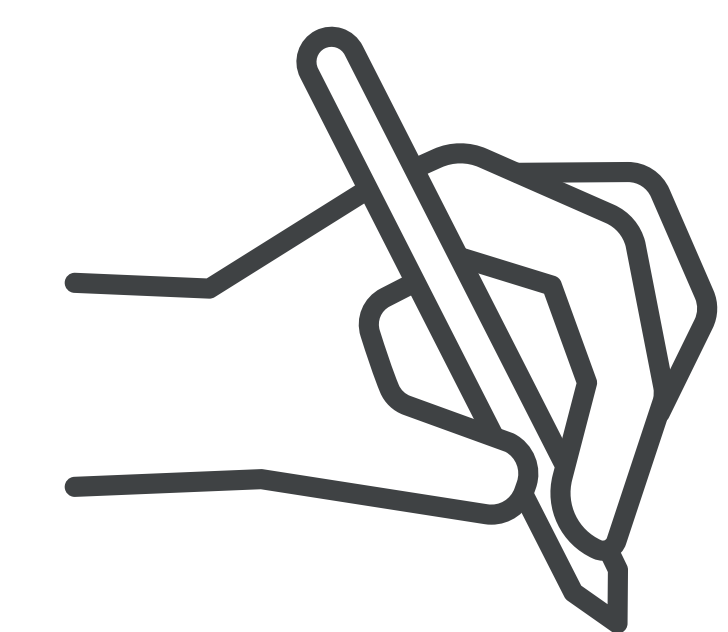

левая рука

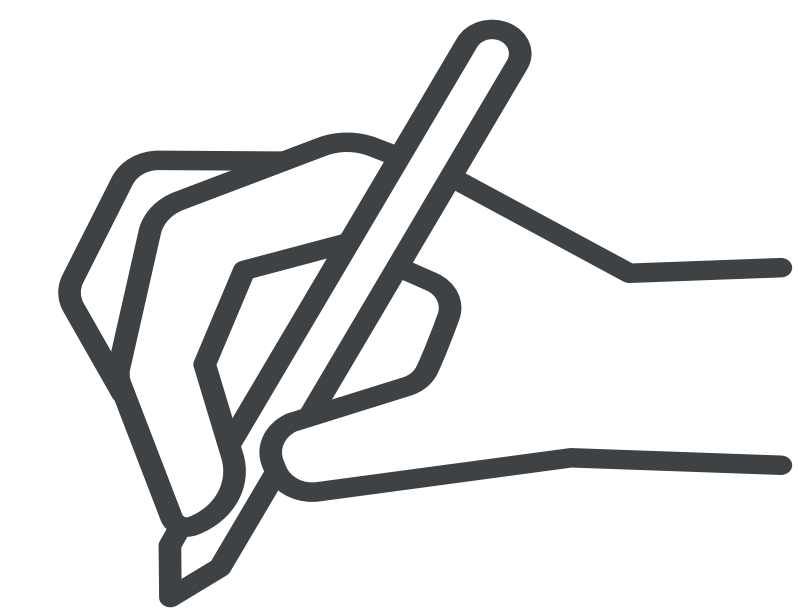

правая рука



deti-i-mama.ru



vini.by



Л'

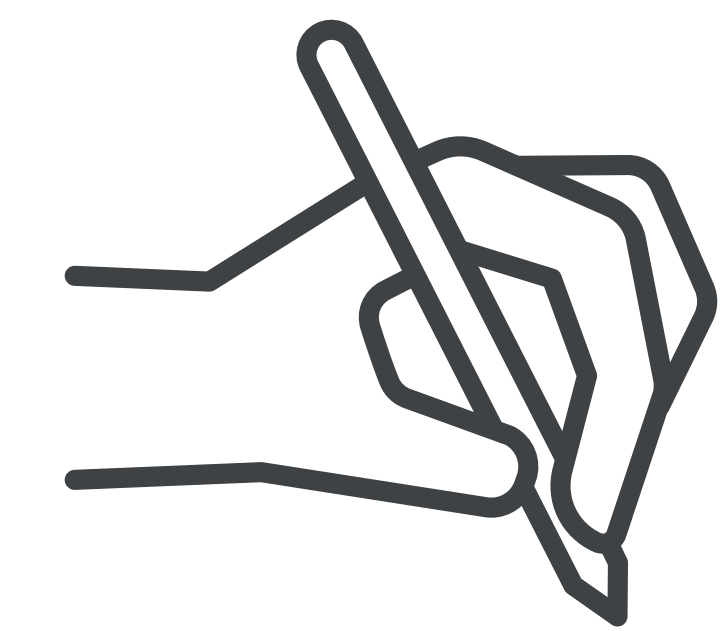

левая рука

Найди и назови одинаковые картинки слева и справа. Обведи их двумя руками одновременно

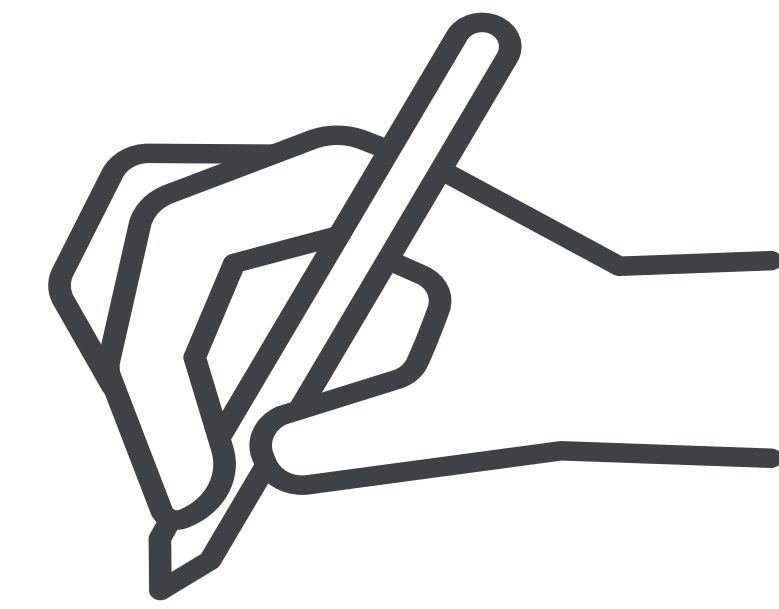

правая рука

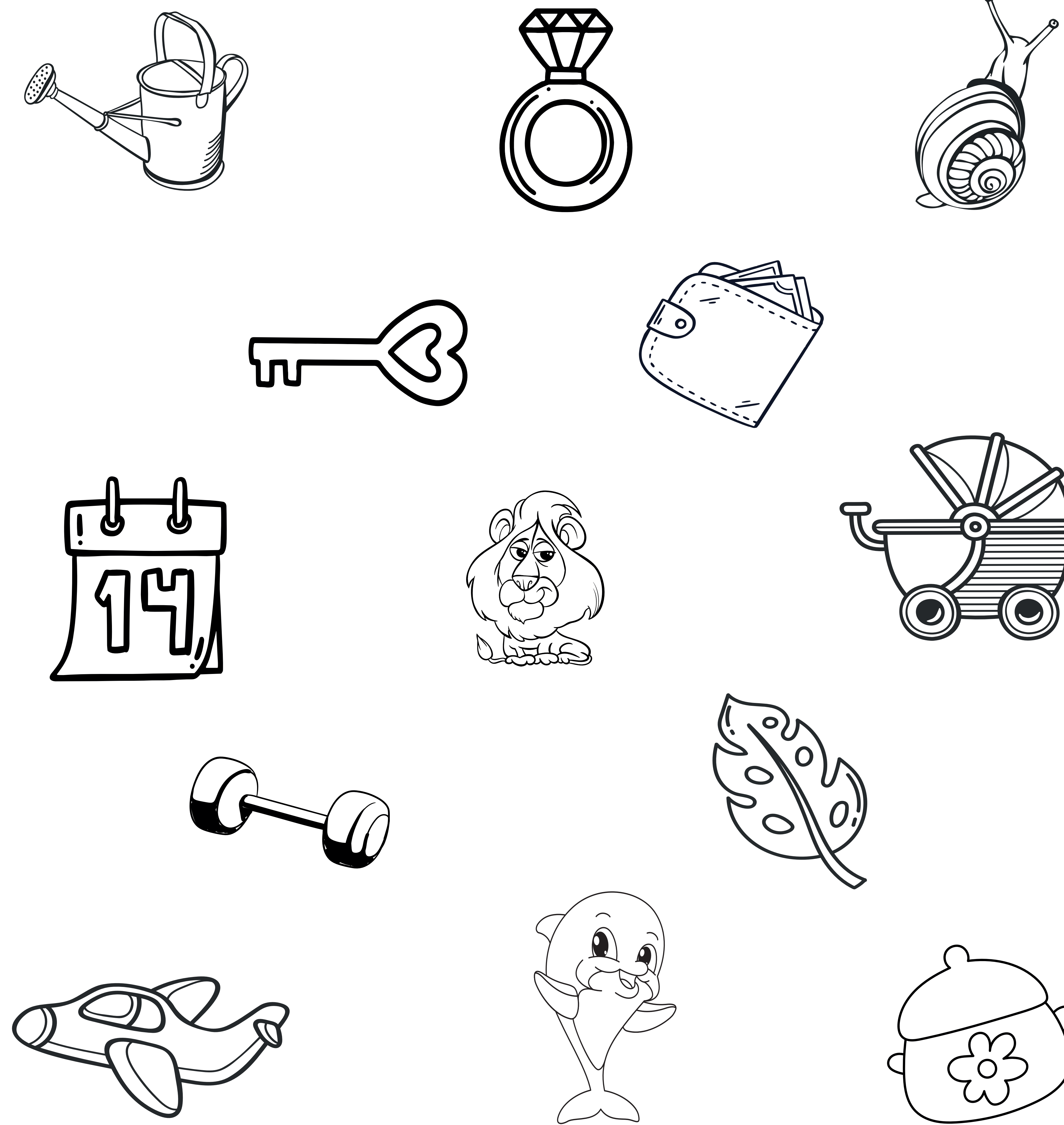
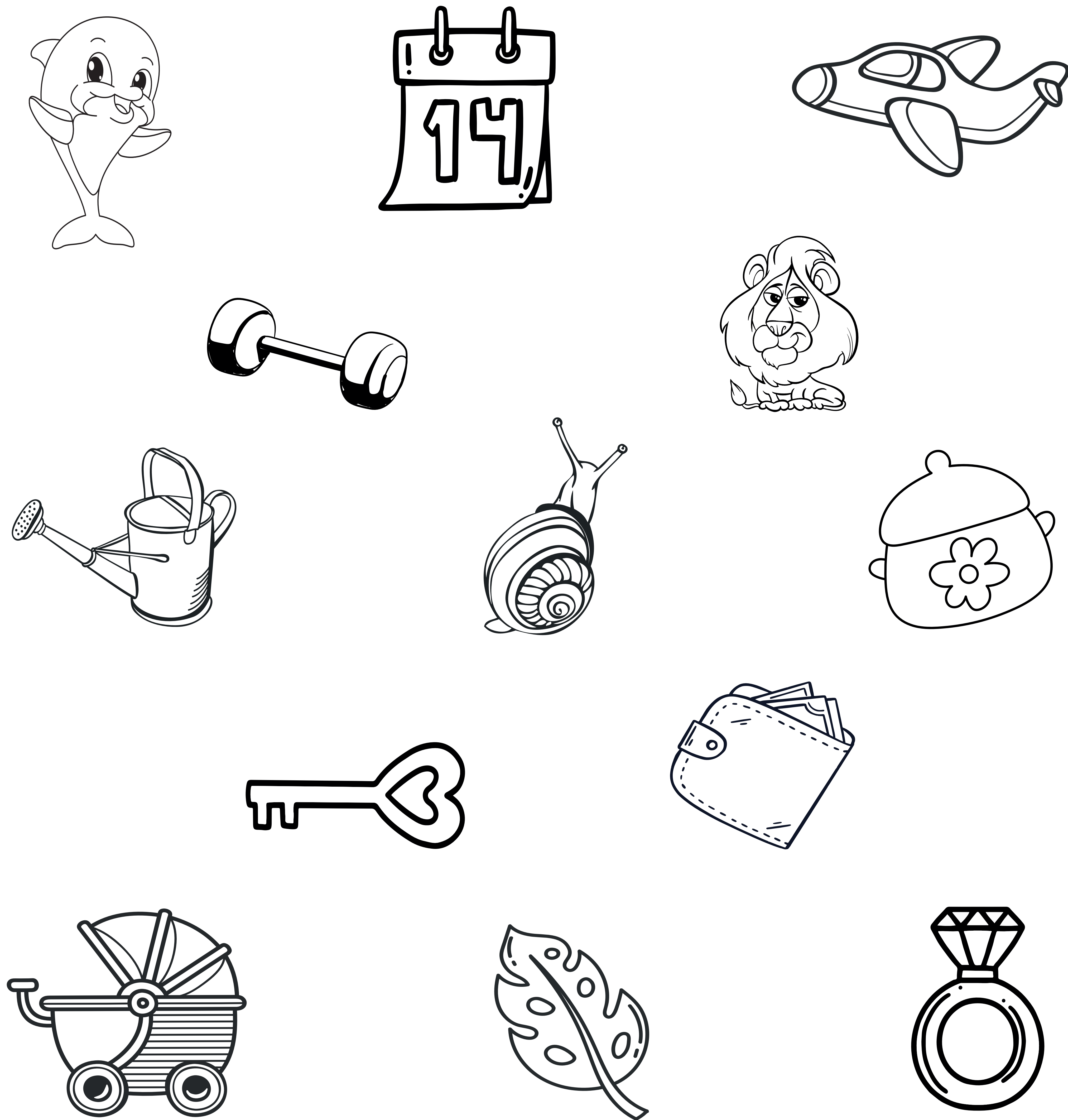



Р

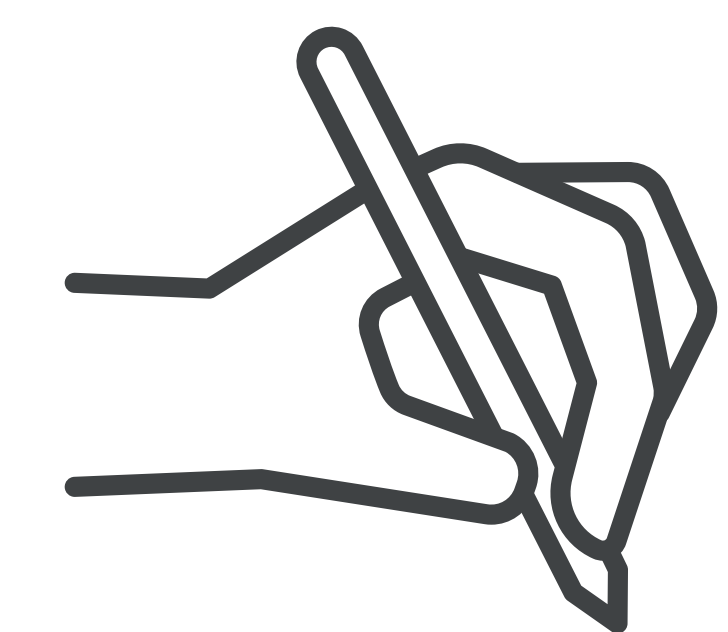

левая рука

Найди и назови одинаковые картинки слева и справа. Обведи их двумя руками одновременно

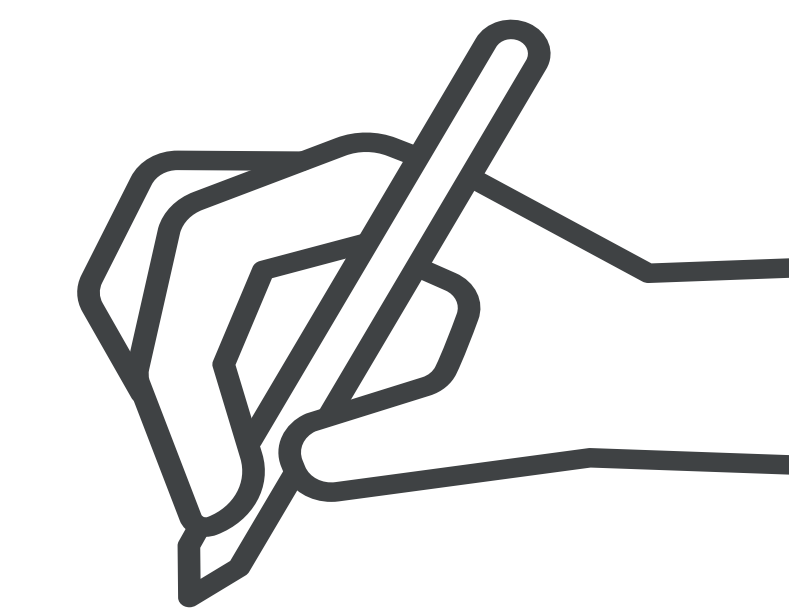

правая рука

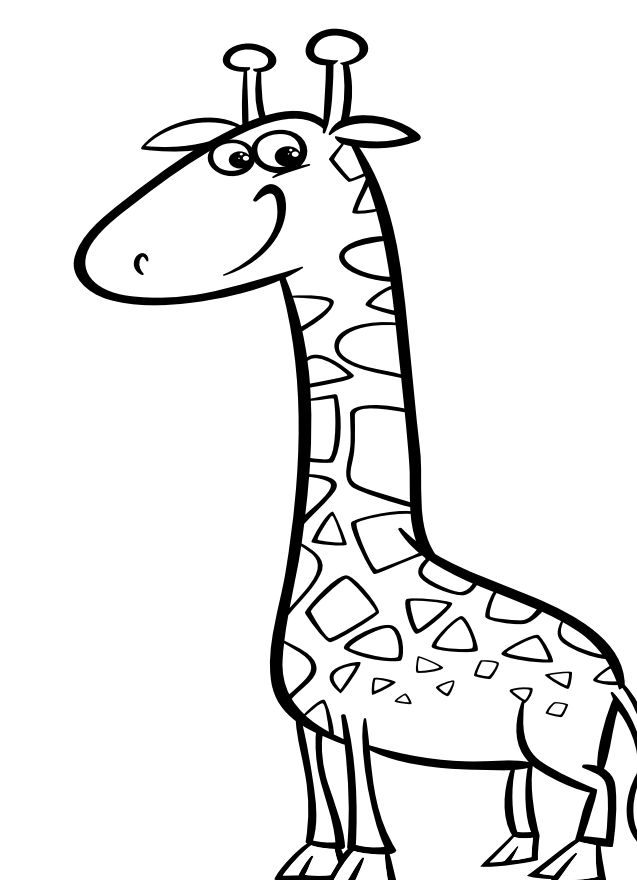
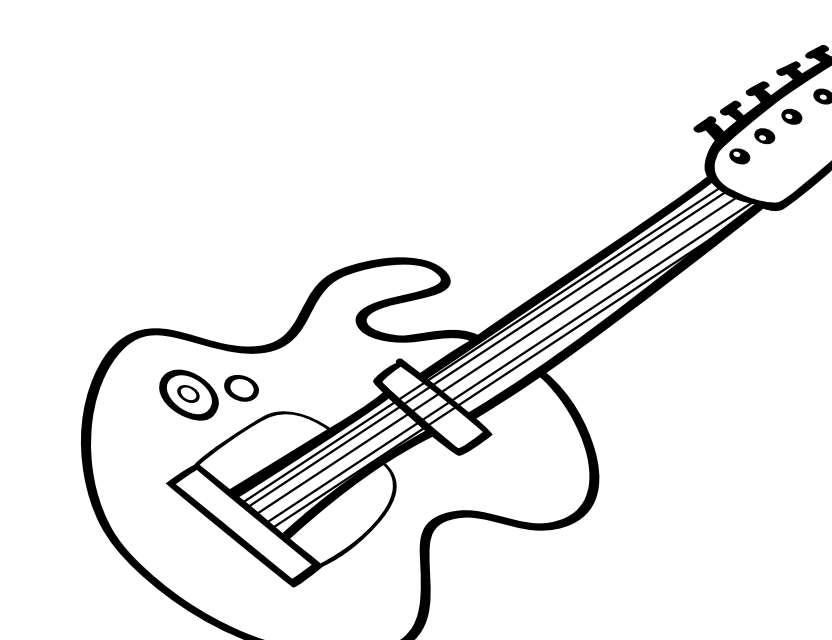
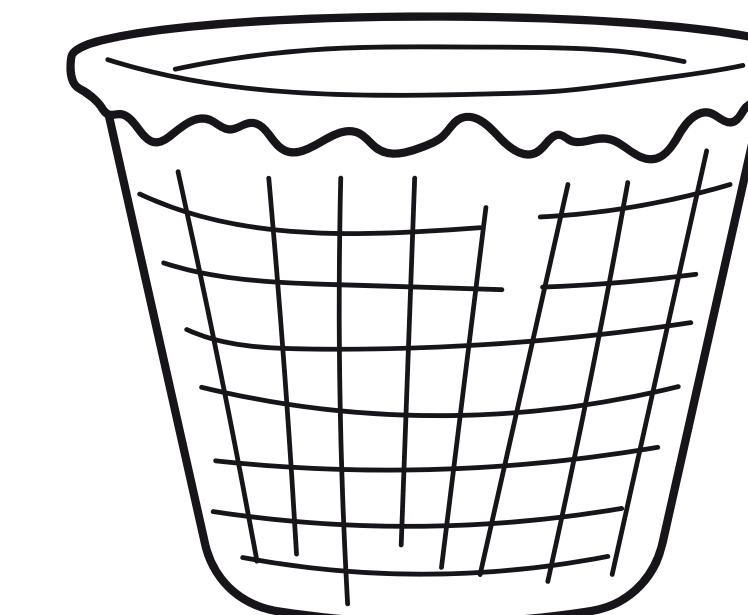
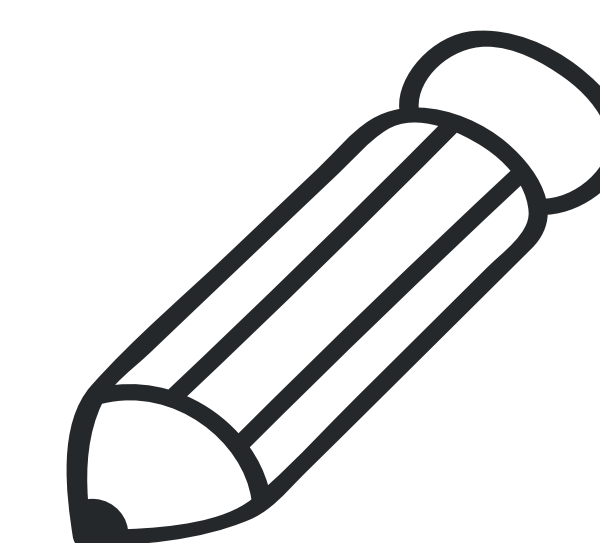
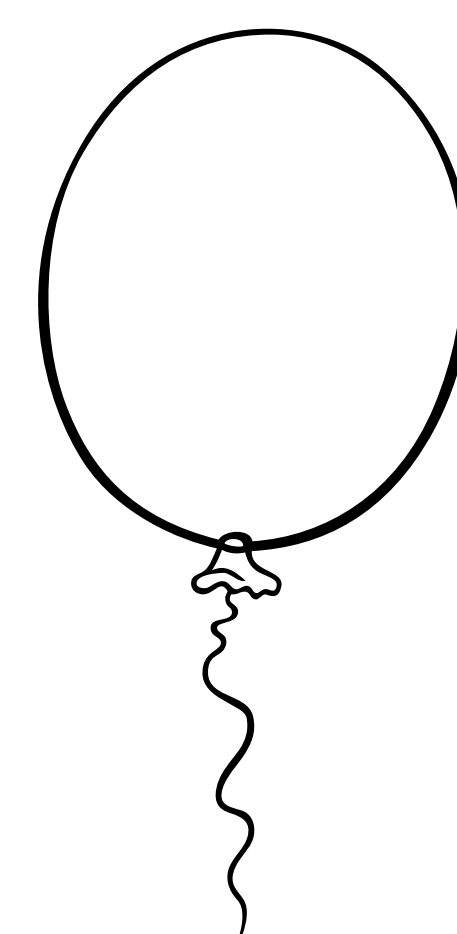
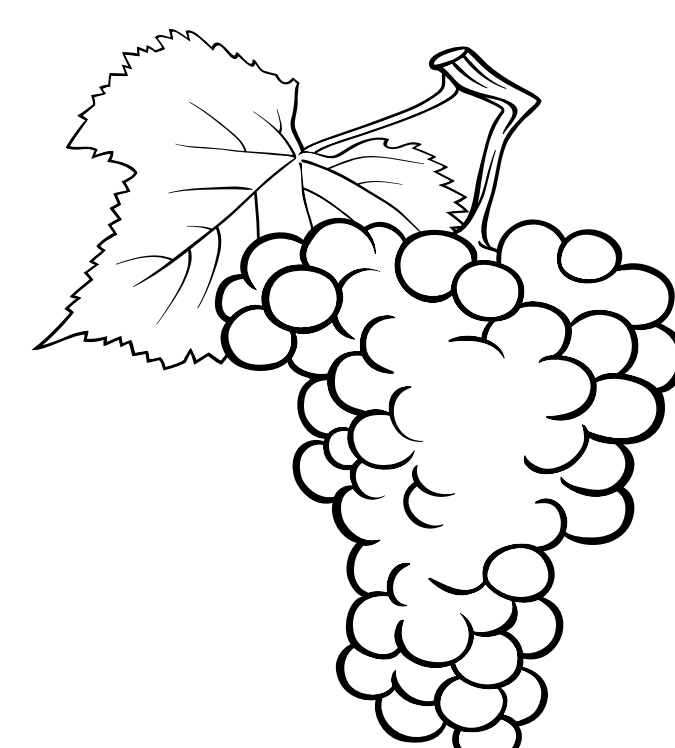
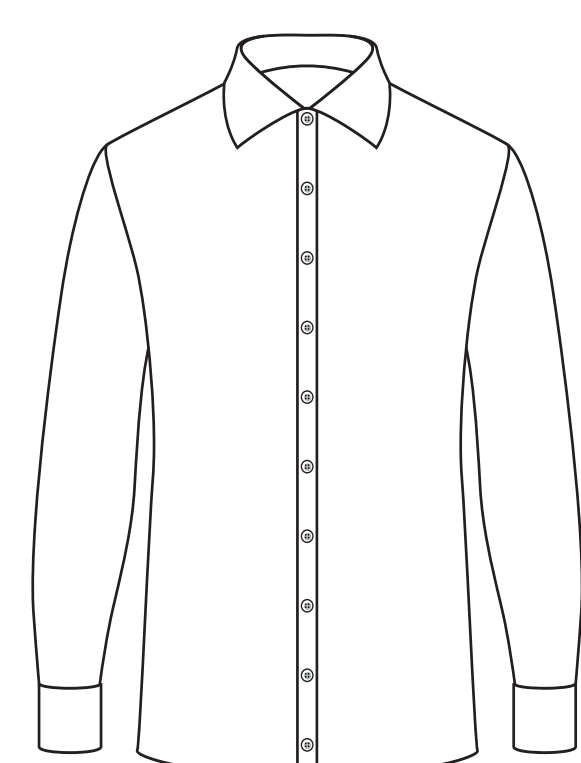
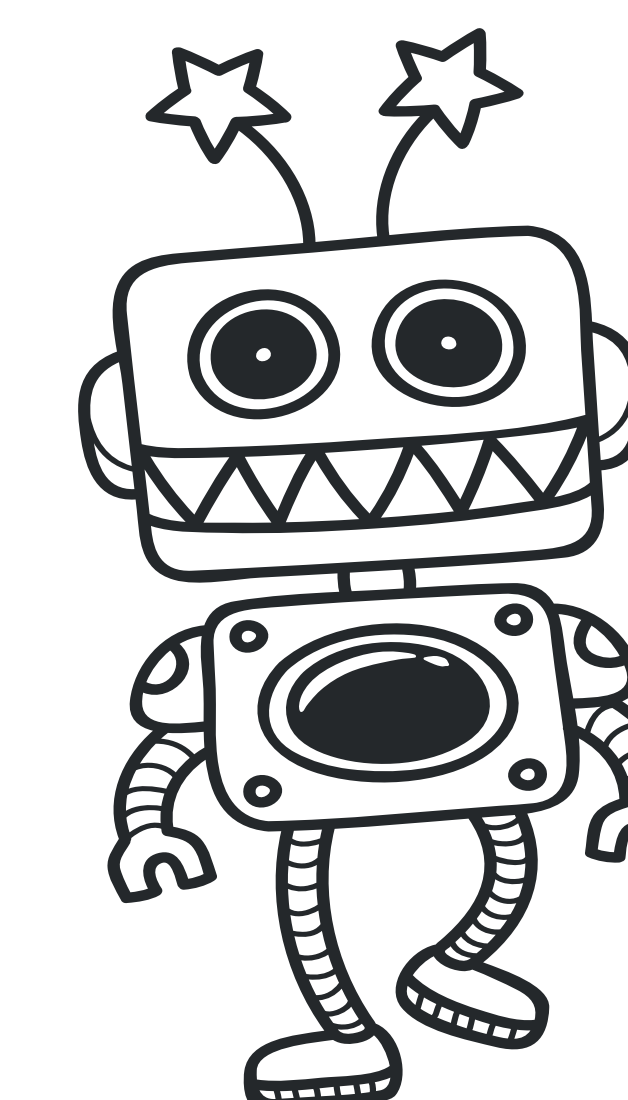
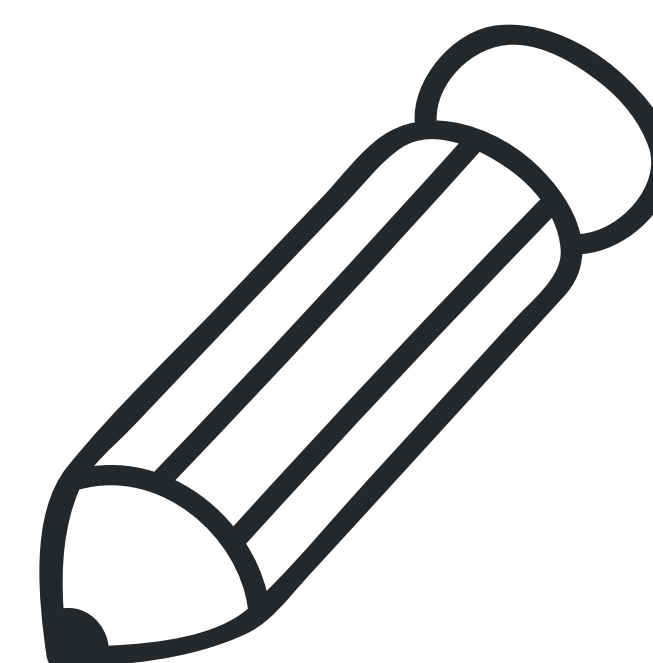
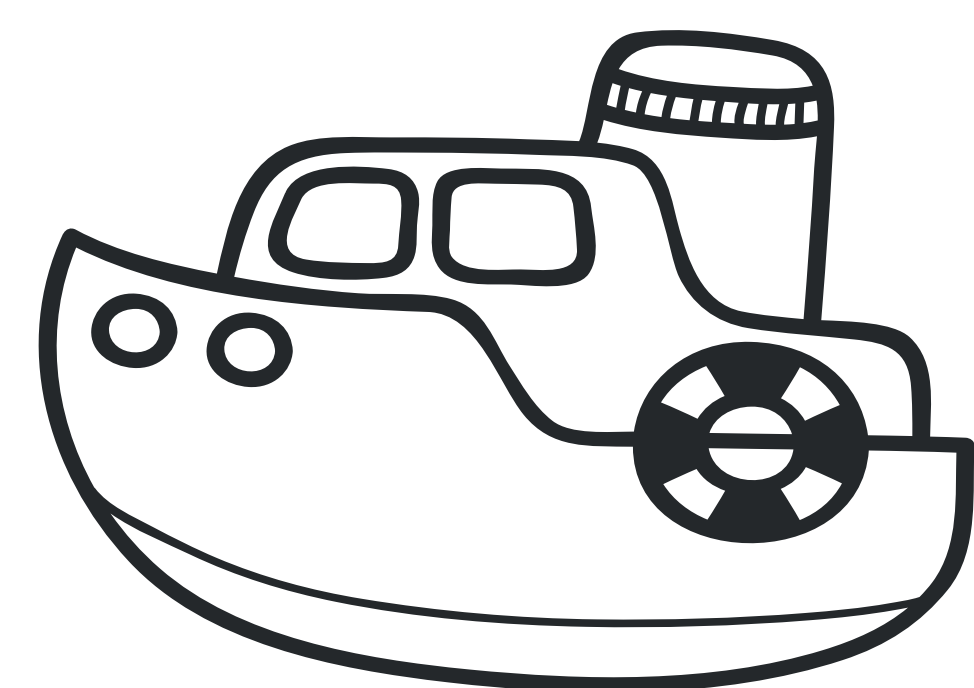
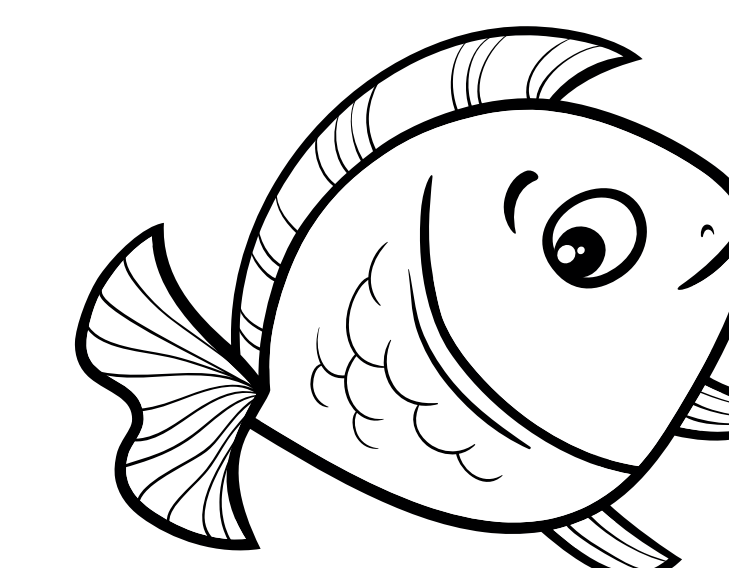
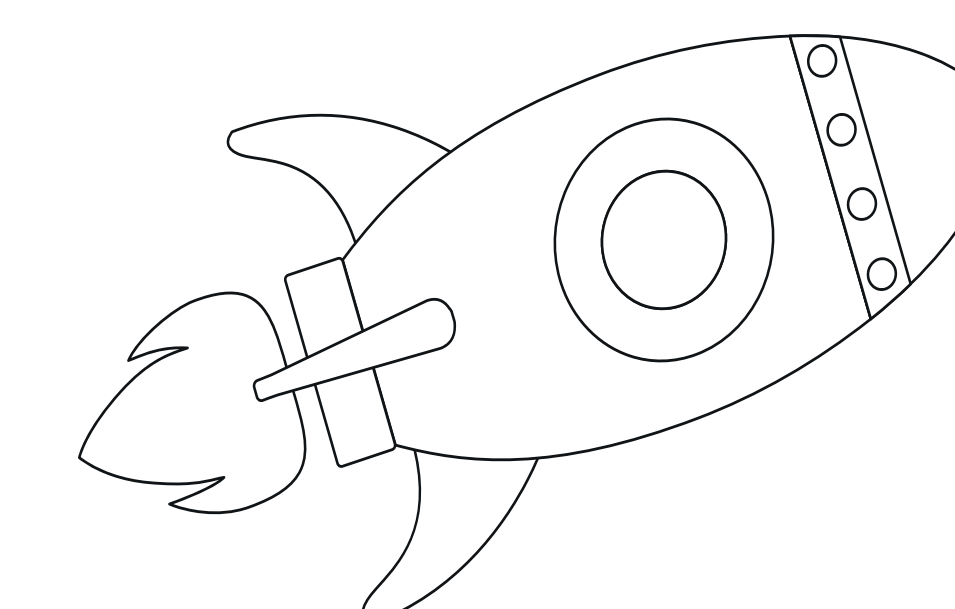
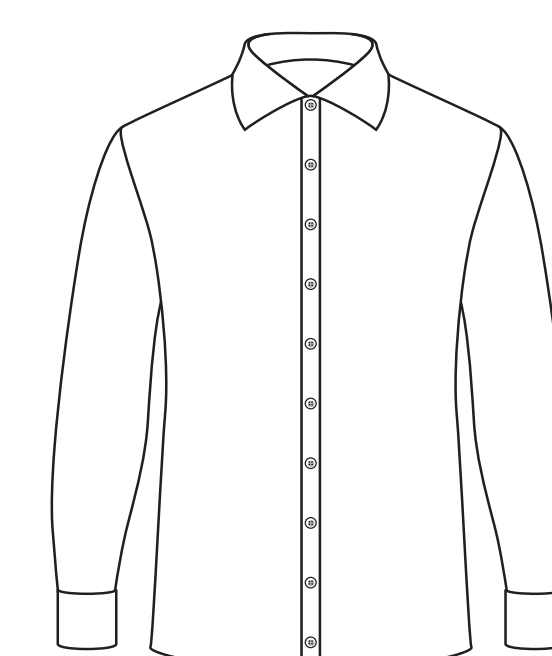
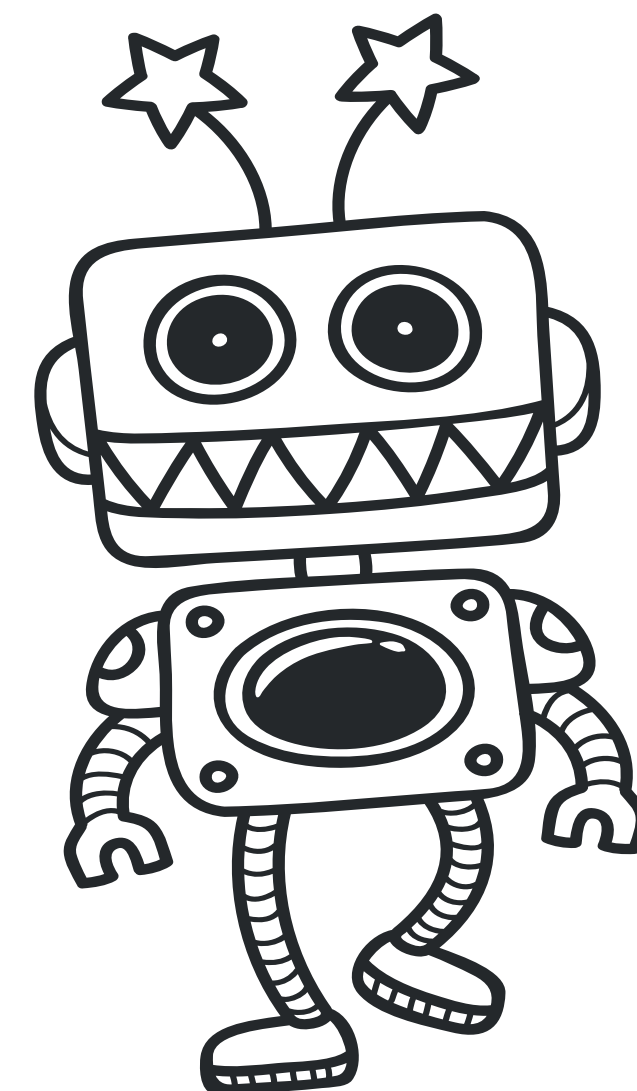
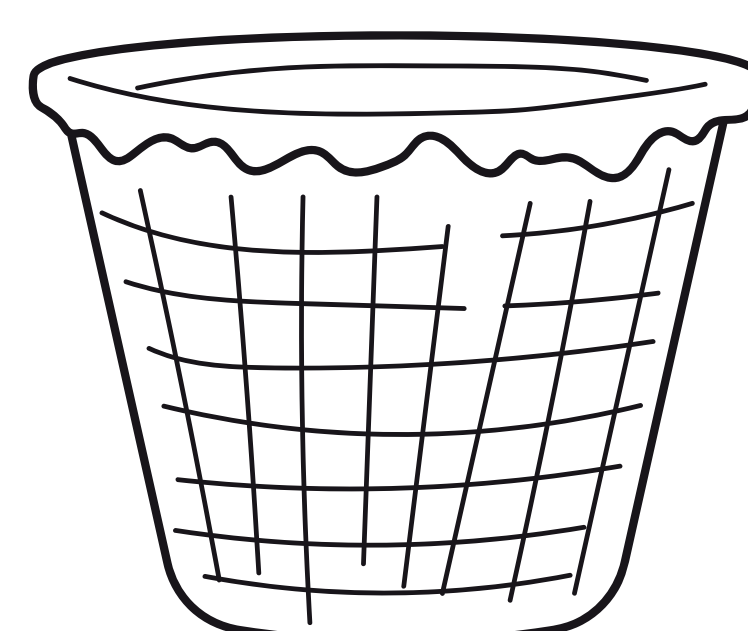
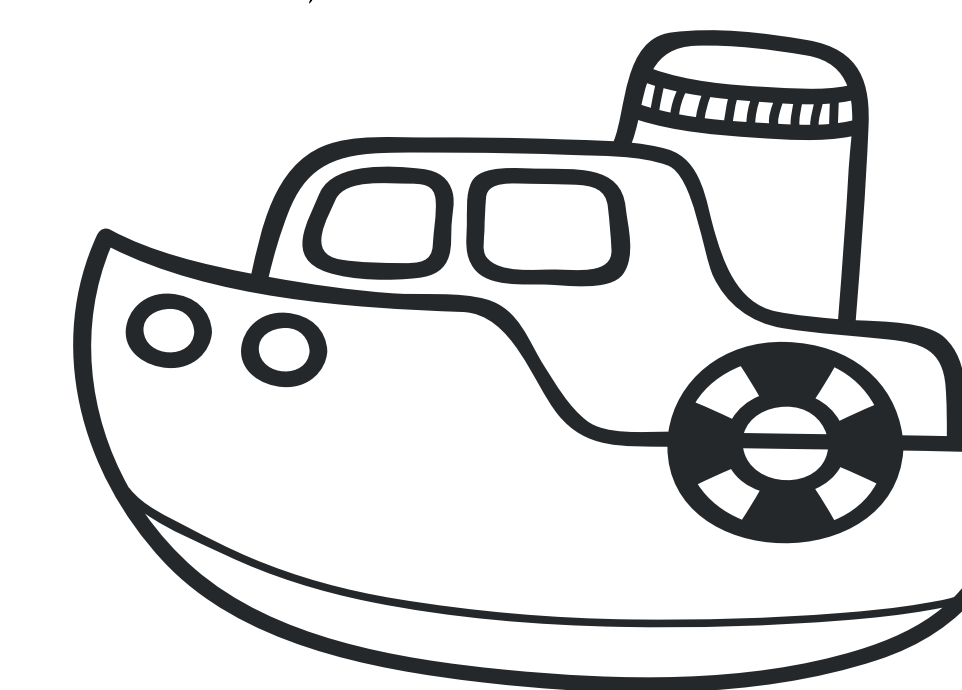
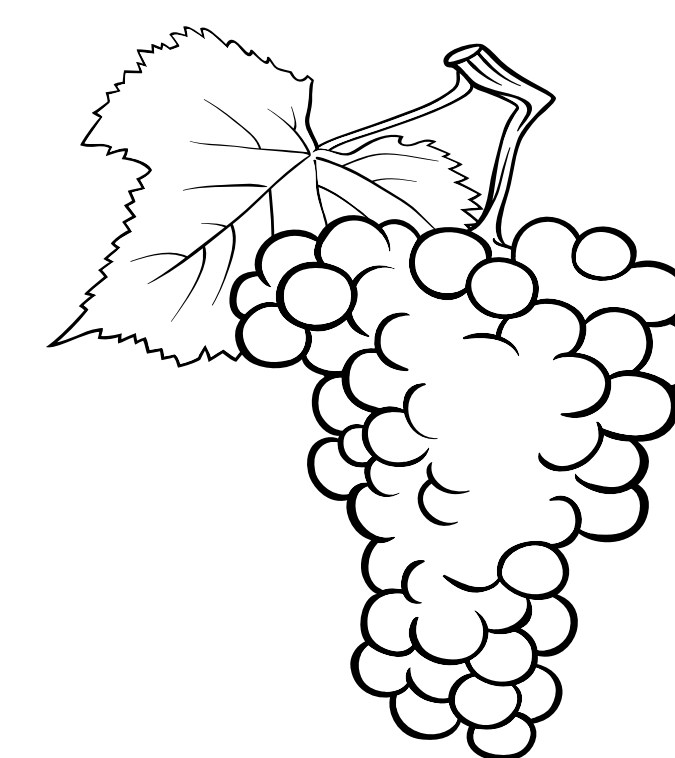
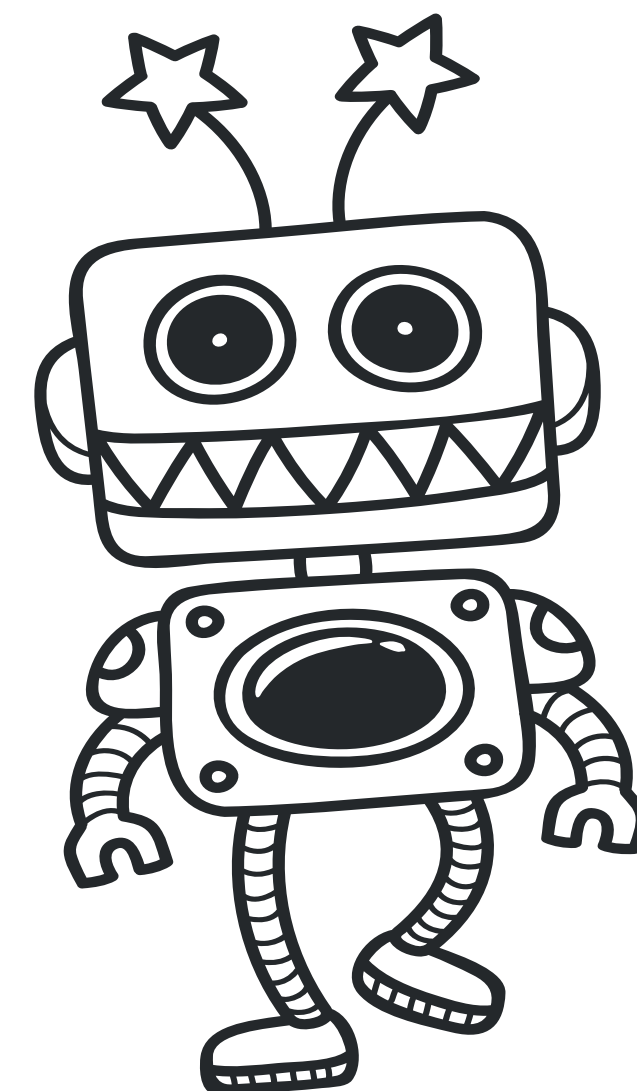
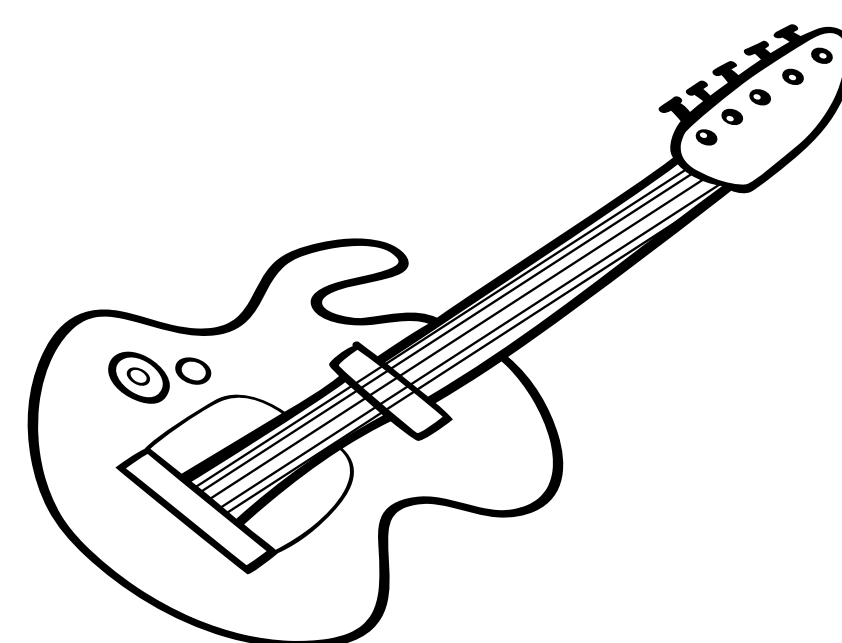
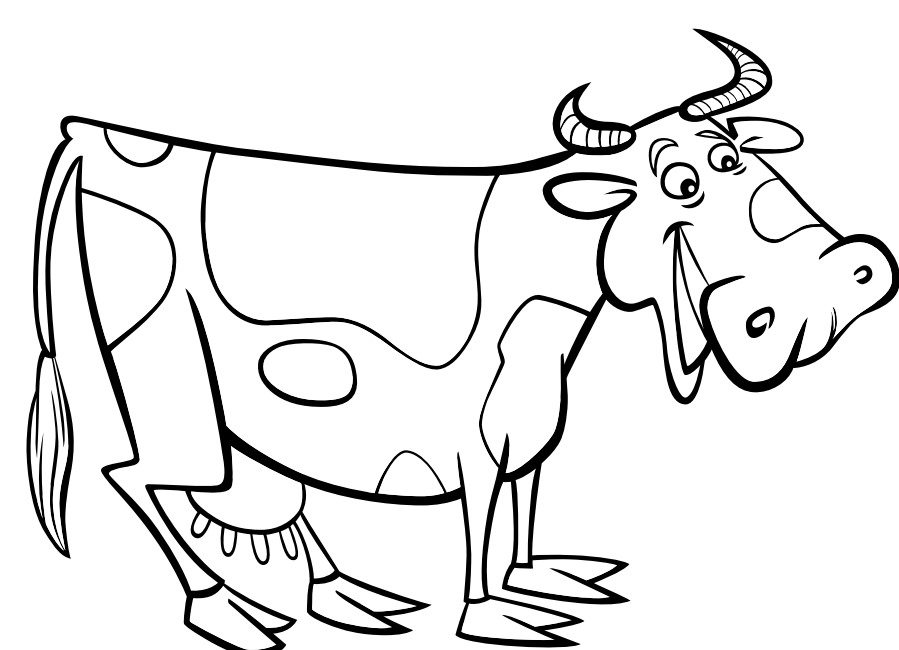
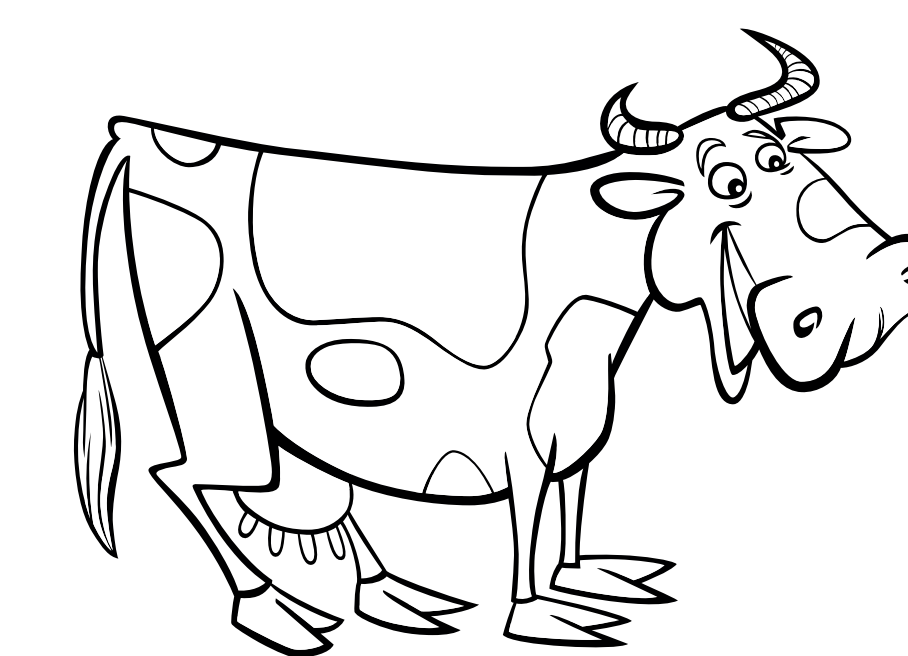
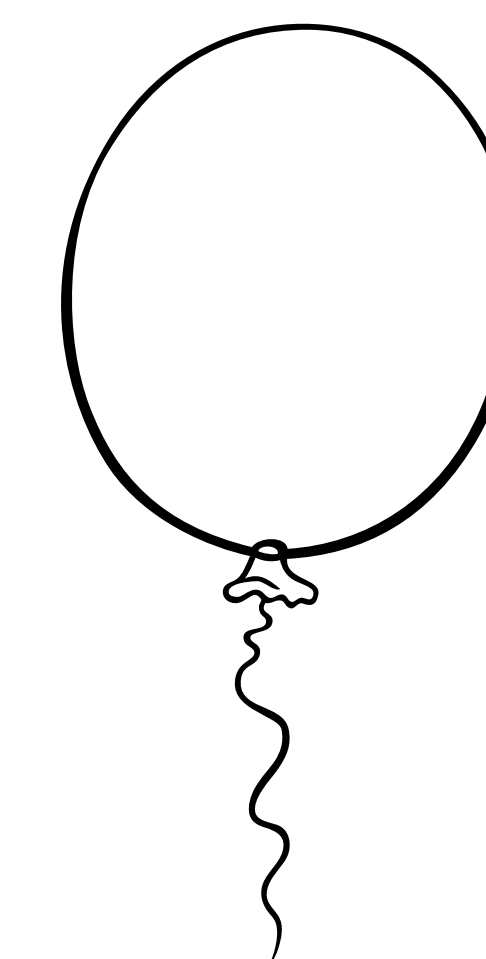
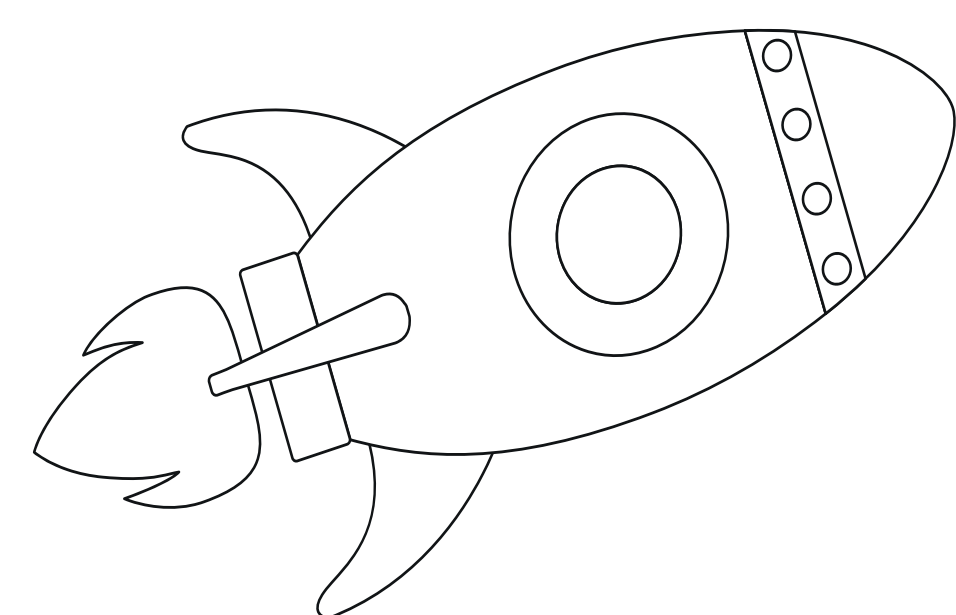
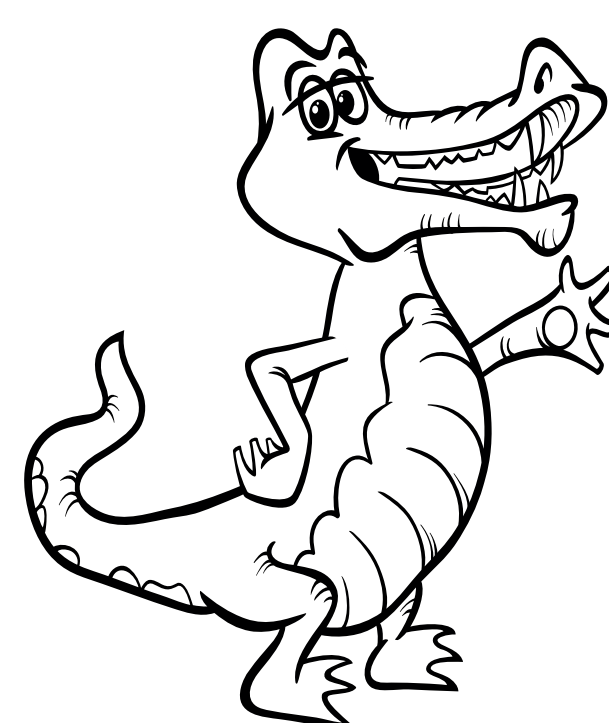
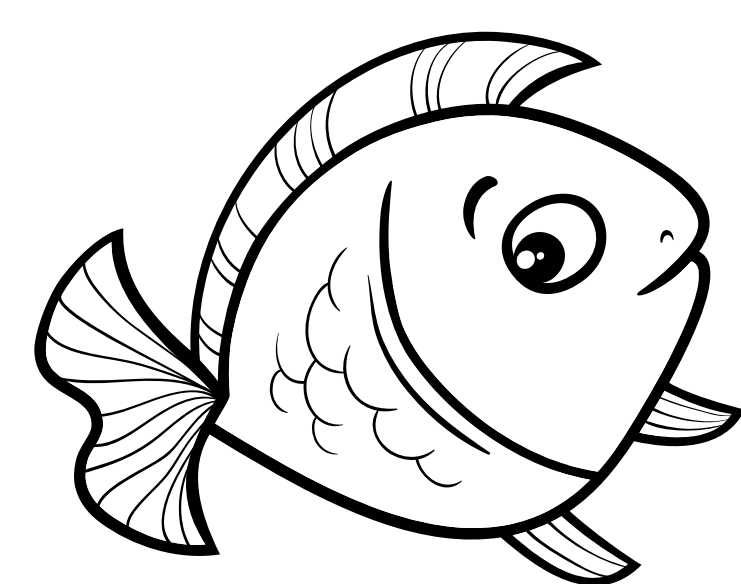

deti-i-mama.ru

vini.by



Р'

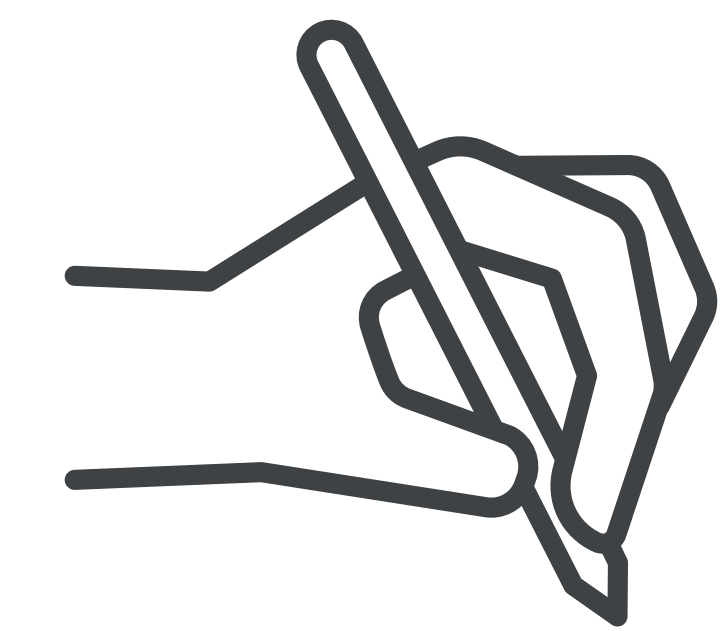

левая рука

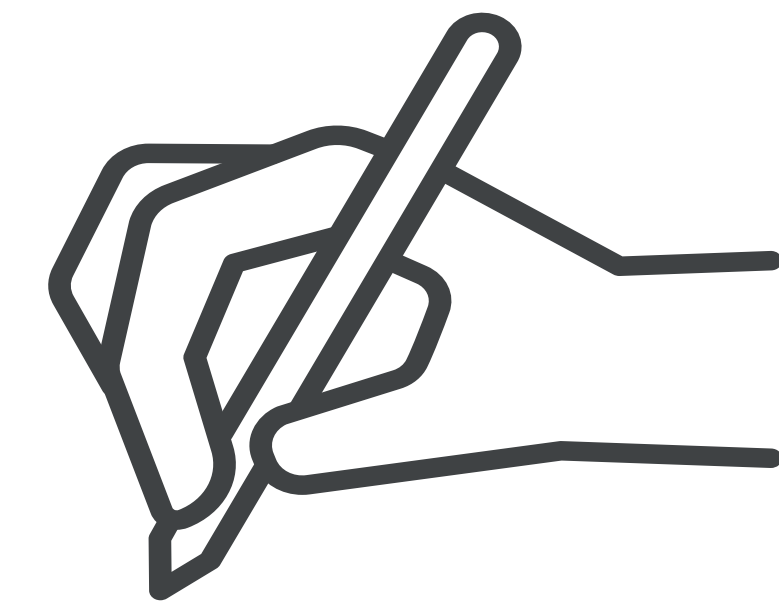

правая рука

Найди и назови одинаковые картинки слева и справа. Обведи их двумя руками одновременно



deti-i-mama.ru

vini.by